

INTRODUCTORY OFFER

30% OFF

ALL PARLEC SHRINKFIT

**OFFER INCLUDES OUR EXPANDED SELECTION
OF COOLANT-PORTED HEAVY-DUTY HOLDERS.**

Our NEW heavy-duty shrinkfit holders deliver the required rigidity and clamping force for heavy chip loads and high metal removal rates.



- Critical dimensions match popular industry standards.
- Coolant supplied directly to the cutting zone drastically improves tool life and chip evacuation.
- Extreme concentricity, 3 Microns.
- Balanced up to 25,000 rpm.

Offer ends 3/31/2020



Parlec is a proud member of Techniks Tool Group.

**CNC TOOLING SOLUTIONS
FROM SPINDLE TO WORKPIECE**

Connect with Techniks Tool Group



ShrinkFit Holders

2 Extreme Precision Shrinkfit Tools

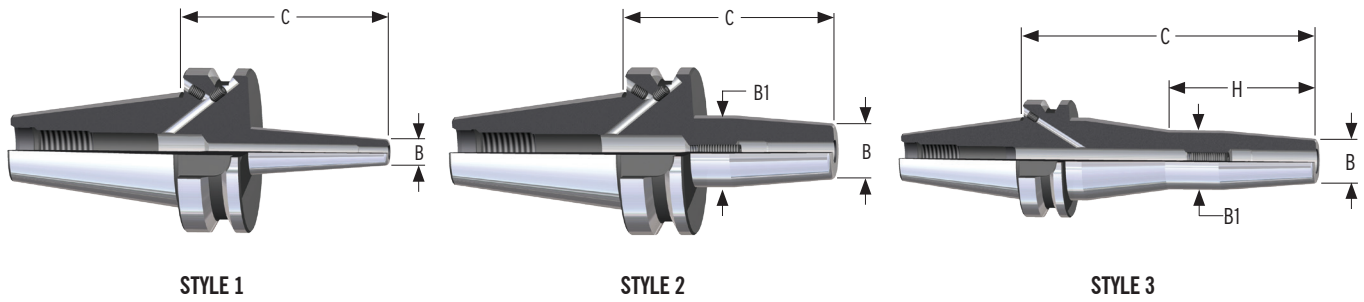

CAT40 SHRINKFIT | STANDARD | INCH

Item ID	Item Description	Size	B	B1	C	Style	List Price	Sale Price
C40A-01SF315-9	Shrink-fit 9 Degree Bal AD/B 1/8" x 3.15"	1/8"	.39"	.62"	3.15"	3	\$280.00	\$196.00
C40A-18SF315-9	Shrink-fit 9 Degree Bal AD/B 3/16"X3.15"	3/16"	.39"	.72"	3.15"	3	\$315.00	\$220.50
C40-18SF315-9	Shrink-Fit 9 Degree Bal AD/B 3/16"x3.15"	3/16"	0.39"	0.72"	3.15"	2	\$267.00	\$186.90
C40-25SF315-9	Shrink-Fit 9 Degree Bal AD/B 1/4"X 3.15"	1/4"	0.83"	1.06"	3.15"	2	\$267.00	\$186.90
C40-25SF630-9	Shrink-Fit 9 Degree Bal AD/B 1/4"X 6.30"	1/4"	0.83"	1.06"	6.30"	3	\$304.00	\$212.80
C40-31SF315-9	Shrink-Fit 9 Degree Bal AD/B 5/16"x3.15"	5/16"	0.83"	1.06"	3.15"	2	\$267.00	\$186.90
C40-31SF630-9	Shrink-Fit 9 Degree Bal AD/B, 5/16x6.3"	5/16"	0.83"	1.06"	6.30"	3	\$304.00	\$212.80
C40-38SF315-9	Shrink-Fit 9 Degree Bal AD/B 3/8"X 3.15"	3/8"	0.94"	1.26"	3.15"	2	\$267.00	\$186.90
C40-38SF630-9	Shrink-Fit 9 Degree Bal AD/B 3/8"X 6.30"	3/8"	0.94"	1.26"	6.30"	3	\$304.00	\$212.80
C40-50SF315-9	Shrink-Fit 9 Degree Bal AD/B 1/2"X 3.15"	1/2"	0.94"	1.26"	3.15"	2	\$267.00	\$186.90
C40-50SF630-9	Shrink-Fit 9 Degree Bal AD/B 1/2"X 6.30"	1/2"	0.94"	1.26"	6.30"	3	\$304.00	\$212.80
C40-62SF315-9	Shrink-Fit 9 Degree Bal AD/B 5/8"X 3.15"	5/8"	1.06"	1.34"	3.15"	2	\$267.00	\$186.90
C40-62SF630-9	Shrink-Fit 9 Degree Bal AD/B 5/8"X 6.30"	5/8"	1.06"	1.34"	6.30"	3	\$304.00	\$212.80
C40-75SF315-9	Shrink-Fit 9 Degree Bal AD/B 3/4"X 3.15"	3/4"	1.3"	1.65"	3.15"	2	\$267.00	\$186.90
C40F-75SF315-9	Shrk Fit Bal, AD/B, 3/4" x 3.15", Simul	3/4"	1.3"	1.65"	3.15"	2	\$326.00	\$228.20
C40-75SF630-9	Shrink-Fit 9 Degree Bal AD/B 3/4"X 6.30"	3/4"	1.3"	1.65"	6.30"	2	\$304.00	\$212.80
C40-10SF394-9	Shrink-Fit 9 Degree Bal AD/B 1"X 3.94"	1"	1.73"	2.09"	3.94"	2	\$267.00	\$186.90
C40F-10SF394-9	Shrk Fit Bal, AD/B 1" x 3.94", Simul	1"	1.3"	1.65"	3.94"	2	\$348.00	\$243.60
C40-10SF630-9	Shrink-Fit 9 Degree Bal AD/B 1"X 6.30"	1"	1.73"	2.09"	6.30"	2	\$304.00	\$212.80
C40-12SF394-9	Shrink-Fit 9 Degree Bal AD/B 1-1/4x3.94	1-1/4"	1.73"	2.09"	3.94"	2	\$267.00	\$186.90

CAT40 SHRINKFIT | STANDARD | METRIC

Item ID	Item Description	Size	B	B1	C	Style	List Price	Sale Price
C40-M06SF80-9	Shrink-Fit 9 Degree Bal AD/B 6 X 80mm	6 mm	21 mm	27 mm	80 mm	2	\$270.00	\$189.00
C40-M08SF80-9	Shrink-Fit 9 Degree Bal AD/B 8 X 80mm	8 mm	21 mm	27 mm	80 mm	2	\$270.00	\$189.00
C40-M10SF80-9	Shrink-Fit 9 Degree Bal AD/B 10 X 80mm	10 mm	24 mm	32 mm	80 mm	2	\$270.00	\$189.00
C40-M12SF80-9	Shrink-Fit 9 Degree Bal AD/B 12 X 80mm	12 mm	24 mm	32 mm	80 mm	2	\$270.00	\$189.00
C40-M16SF80-9	Shrink-Fit 9 Degree Bal AD/B 16 X 80mm	16 mm	27 mm	34 mm	80 mm	2	\$270.00	\$189.00
C40-M20SF80-9	Shrink-Fit 9 Degree Bal AD/B 20 X 80mm	20 mm	33 mm	42 mm	80 mm	2	\$270.00	\$189.00
C40-M25SF100-9	Shrink-Fit 9 Degree Bal AD/B 25 X 100mm	25 mm	44 mm	53 mm	100 mm	2	\$270.00	\$189.00
C40-M32SF100-9	Shrink-Fit 9 Degree Bal AD/B 32 X 100mm	32 mm	44 mm	53 mm	100 mm	2	\$241.00	\$168.70

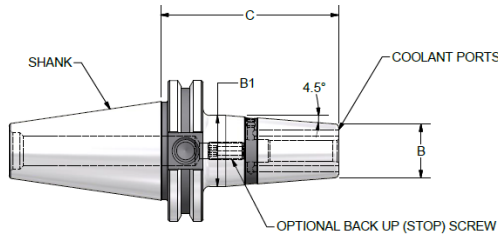

Style 1

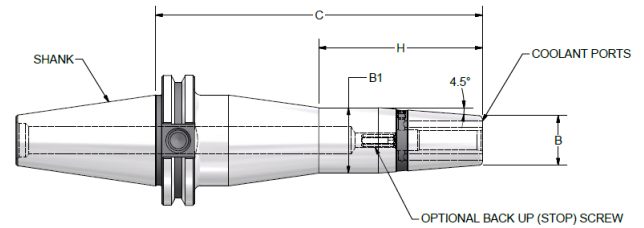

Style 2

CAT40 SHRINKFIT | COOLANT PORTED | INCH

Item ID	Item Description	Size	B	B1	C	Style	List Price	Sale Price
C40A-25SF315-9C	Shrink-fit 9° Bal Cool Prt 1/4 x 3.15"	1/4"	.83"	1.06"	3.15"	1	\$250.00	\$175.00
C40A-25SF512-9C	Shrink-fit 9° Bal Cool Prt 1/4 x 5.12"	1/4"	.83"	1.06"	5.12"	1	\$350.00	\$245.00
C40A-25SF630-9C	Shrink-fit 9° Bal Cool Prt 1/4 x 6.30"	1/4"	.83"	1.06"	6.30"	2	\$355.00	\$248.50
C40A-31SF315-9C	Shrink-fit 9° Bal Cool Prt 5/16 x 3.15"	5/16"	.83"	1.06"	3.15"	1	\$265.00	\$185.50
C40A-38SF315-9C	Shrink-fit 9° Bal Cool Prt 3/8 x 3.15"	3/8"	.94"	1.26"	3.15"	1	\$265.00	\$185.50
C40A-38SF512-9C	Shrink-fit 9° Bal Cool Prt 3/8 x 5.12"	3/8"	.94"	1.26"	5.12"	1	\$350.00	\$245.00
C40A-38SF630-9C	Shrink-fit 9° Bal Cool Prt 3/8 x 6.30"	3/8"	.94"	1.26"	6.30"	2	\$355.00	\$248.50
C40A-50SF315-9C	Shrink-fit 9° Bal Cool Prt 1/2 x 3.15"	1/2"	.94"	1.26"	3.15"	1	\$265.00	\$185.50
C40A-50SF512-9C	Shrink-fit 9° Bal Cool Prt 1/2 x 5.12"	1/2"	.94"	1.26"	5.12"	1	\$350.00	\$245.00
C40A-50SF630-9C	Shrink-fit 9° Bal Cool Prt 1/2 x 6.30"	1/2"	.94"	1.26"	6.30"	2	\$355.00	\$248.50
C40A-62SF315-9C	Shrink-fit 9° Bal Cool Prt 5/8 x 3.15"	5/8"	1.06"	1.34"	3.15"	1	\$265.00	\$185.50
C40A-62SF512-9C	Shrink-fit 9° Bal Cool Prt 5/8 x 5.12"	5/8"	1.06"	1.34"	5.12"	1	\$350.00	\$245.00
C40A-62SF630-9C	Shrink-fit 9° Bal Cool Prt 5/8 x 6.30"	5/8"	1.06"	1.34"	6.30"	2	\$355.00	\$248.50
C40A-75SF315-9C	Shrink-fit 9° Bal Cool Prt 3/4 x 3.15"	3/4"	1.30"	1.65"	3.15"	1	\$265.00	\$185.50
C40A-75SF512-9C	Shrink-fit 9° Bal Cool Prt 3/4 x 5.12"	3/4"	1.30"	1.65"	5.12"	1	\$350.00	\$245.00
C40A-75SF630-9C	Shrink-fit 9° Bal Cool Prt 3/4 x 6.30"	3/4"	1.30"	1.65"	6.30"	2	\$355.00	\$248.50
C40A-10SF394-9C	Shrink-fit 9° Bal Cool Prt 1 x 3.94"	1"	1.73"	2.09"	3.94"	1	\$280.00	\$196.00
C40A-10SF512-9C	Shrink-fit 9° Bal Cool Prt 1 x 5.12"	1"	1.73"	2.09"	5.12"	1	\$372.00	\$260.40
C40A-10SF630-9C	Shrink-fit 9° Bal Cool Prt 1 x 6.30"	1"	1.73"	2.09"	6.30"	2	\$375.00	\$262.50
C40A-12SF394-9C	Shrink-fit 9° Bal Cool Prt 1-1/4 x 3.94"	1-1/4"	1.73"	2.09"	3.94"	1	\$265.00	\$185.50

ShrinkFit Holders

4 Extreme Precision Shrinkfit Tools

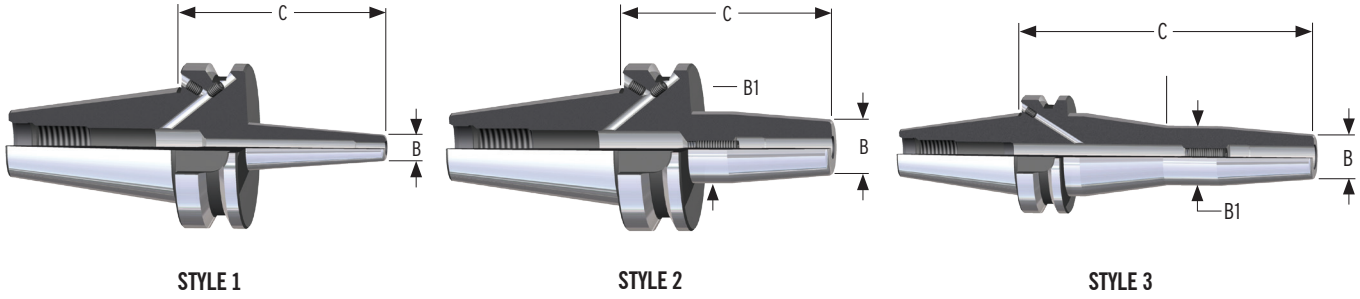

CAT50 SHRINKFIT | STANDARD | INCH

Item ID	Item Description	Size	B	B1	C	Style	List Price	Sale Price
C50-25SF315-9	Shrink-Fit 9 Degree Bal AD/B 1/4"X 3.15"	1/4"	0.83"	1.06"	3.15"	2	\$337.00	\$235.90
C50-25SF630-9	Shrink-Fit 9 Degree Bal AD/B 1/4"X 6.30"	1/4"	0.83"	1.06"	6.30"	3	\$438.00	\$306.60
C50-31SF315-9	Shrink-Fit 9 Degree Bal AD/B 5/16"X 3.15"	5/16"	0.83"	1.06"	3.15"	2	\$337.00	\$235.90
C50-31SF630-9	Shrink-Fit 9 Degree Bal AD/B 5/16"X 6.3"	5/16"	0.83"	1.06"	6.30"	3	\$438.00	\$306.60
C50-38SF315-9	Shrink-Fit 9 Degree Bal AD/B 3/8"X 3.15"	3/8"	0.94"	1.26"	3.15"	2	\$337.00	\$235.90
C50-38SF630-9	Shrink-Fit 9 Degree Bal AD/B 3/8"X 6.30"	3/8"	0.94"	1.26"	6.30"	3	\$438.00	\$306.60
C50-50SF315-9	Shrink-Fit 9 Degree Bal AD/B 1/2"X 3.15"	1/2"	0.94"	1.26"	3.15"	2	\$337.00	\$235.90
C50-50SF630-9	Shrink-Fit 9 Degree Bal AD/B 1/2"X 6.30"	1/2"	0.94"	1.26"	6.30"	3	\$438.00	\$306.60
C50-62SF315-9	Shrink-Fit 9 Degree Bal AD/B 5/8"X 3.15"	5/8"	1.06"	1.34"	3.15"	2	\$337.00	\$235.90
C50-62SF630-9	Shrink-Fit 9 Degree Bal AD/B 5/8"X 6.30"	5/8"	1.06"	1.34"	6.30"	3	\$438.00	\$306.60
C50-75SF315-9	Shrink-Fit 9 Degree Bal AD/B 3/4"X 3.15"	3/4"	1.30"	1.65"	3.15"	2	\$337.00	\$235.90
C50-75SF630-9	Shrink-Fit 9 Degree Bal AD/B 3/4"X 6.30"	3/4"	1.30"	1.65"	6.30"	3	\$438.00	\$306.60
C50-10SF394-9	Shrink-Fit 9 Degree Bal AD/B 1"X 3.94"	1"	1.73"	2.09"	3.94"	2	\$337.00	\$235.90
C50-10SF630-9	Shrink-Fit 9 Degree Bal AD/B 1"X 6.30"	1"	1.73"	2.09"	6.30"	2	\$438.00	\$306.60
C50-12SF394-9	Shrink-Fit 9 Degree Bal AD/B 1 1/4" X 3.94"	1-1/4"	1.73"	2.09"	3.94"	2	\$337.00	\$235.90
C50-12SF630-9	Shrink-Fit 9 Degree Bal AD/B 1 1/4"X 6.3"	1-1/4"	1.73"	2.09"	6.30"	2	\$438.00	\$306.60

CAT50 SHRINKFIT | STANDARD | METRIC

Item ID	Item Description	Size	B	B1	C	Style	List Price	Sale Price
C50-M06SF160-9	Shrink-Fit 9 Degree Bal AD/B 6 X 160mm	6 mm	21 mm	27 mm	160 mm	3	\$438.00	\$306.60
C50-M06SF80-9	Shrink-Fit 9 Degree Bal AD/B 6 X 80mm	6 mm	21 mm	27 mm	80 mm	2	\$337.00	\$235.90
C50-M08SF160-9	Shrink-Fit 9 Degree Bal AD/B 8 X 160mm	8 mm	21 mm	27 mm	160 mm	3	\$438.00	\$306.60
C50-M08SF80-9	Shrink-Fit 9 Degree Bal AD/B 8 X 80mm	8 mm	21 mm	27 mm	80 mm	2	\$337.00	\$235.90
C50-M10SF160-9	Shrink-Fit 9 Degree Bal AD/B 10 X 160mm	10 mm	24 mm	32 mm	160 mm	2	\$438.00	\$306.60
C50-M10SF80-9	Shrink-Fit 9 Degree Bal AD/B 10 X 80mm	10 mm	24 mm	32 mm	80 mm	2	\$337.00	\$235.90
C50-M12SF160-9	Shrink-Fit 9 Degree Bal AD/B 12 X 160mm	12 mm	24 mm	32 mm	160 mm	2	\$438.00	\$306.60
C50-M12SF80-9	Shrink-Fit 9 Degree Bal AD/B 12 X 80mm	12 mm	24 mm	32 mm	80 mm	2	\$337.00	\$235.90
C50-M16SF160-9	Shrink-Fit 9 Degree Bal AD/B 16 X 160mm	16 mm	27 mm	34 mm	160 mm	3	\$438.00	\$306.60
C50-M16SF80-9	Shrink-Fit 9 Degree Bal AD/B 16 X 80mm	16 mm	27 mm	34 mm	80 mm	2	\$337.00	\$235.90
C50-M20SF160-9	Shrink-Fit 9 Degree Bal AD/B 20 X 160mm	20 mm	33 mm	42 mm	160 mm	3	\$438.00	\$306.60
C50-M20SF80-9	Shrink-Fit 9 Degree Bal AD/B 20 X 80mm	20 mm	33 mm	42 mm	80 mm	2	\$337.00	\$235.90
C50-M25SF100-9	Shrink-Fit 9 Degree Bal AD/B 25 X 100mm	25 mm	44 mm	53 mm	100 mm	2	\$337.00	\$235.90
C50-M25SF160-9	Shrink-Fit 9 Degree Bal AD/B 25 X 160mm	25 mm	44 mm	53 mm	160 mm	2	\$337.00	\$235.90
C50-M32SF100-9	Shrink-Fit 9 DEG, BAL, AD/B 32 X 100MM	32 mm	44 mm	53 mm	100 mm	2	\$438.00	\$306.60
C50-M32SF160-9	Shrink-Fit 9 DEG, BAL, AD/B 32 X 160MM	32 mm	44 mm	53 mm	160 mm	2	\$438.00	\$306.60

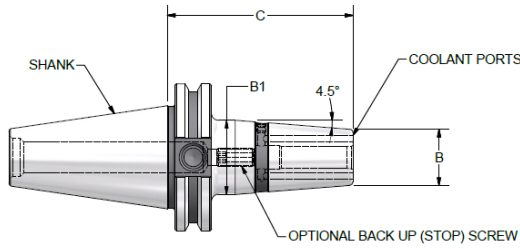

Style 1

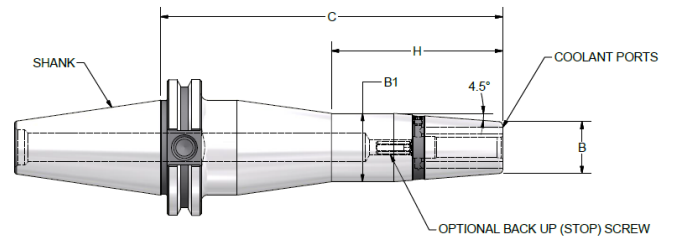

Style 2

CAT50 SHRINKFIT | COOLANT PORTED | INCH

Item ID	Item Description	Size	B	B1	C	Style	List Price	Sale Price
C50A-25SF315-9C	Shrink-fit 9° Bal Cool Prt 1/4 x 3.15"	1/4"	.83"	1.06"	3.15"	1	\$410.00	\$287.00
C50A-25SF512-9C	Shrink-fit 9° Bal Cool Prt 1/4 x 5.12"	1/4"	.83"	1.06"	5.12"	1	\$458.00	\$320.60
C50A-25SF630-9C	Shrink-fit 9° Bal Cool Prt 1/4 x 6.30"	1/4"	.83"	1.06"	6.30"	2	\$506.00	\$354.20
C50A-31SF315-9C	Shrink-fit 9° Bal Cool Prt 5/16 x 3.15"	5/16"	.83"	1.06"	3.15"	1	\$410.00	\$287.00
C50A-31SF512-9C	Shrink-fit 9° Bal Cool Prt 5/16 x 5.12"	5/16"	.83"	1.06"	5.12"	1	\$458.00	\$320.60
C50A-31SF630-9C	Shrink-fit 9° Bal Cool Prt 5/16 x 6.30"	5/16"	.83"	1.06"	6.30"	2	\$506.00	\$354.20
C50A-38SF315-9C	Shrink-fit 9° Bal Cool Prt 3/8 x 3.15"	3/8"	.94"	1.26"	3.15"	1	\$410.00	\$287.00
C50A-38SF512-9C	Shrink-fit 9° Bal Cool Prt 3/8 x 5.12"	3/8"	.94"	1.26"	5.12"	1	\$458.00	\$320.60
C50A-38SF630-9C	Shrink-fit 9° Bal Cool Prt 3/8 x 6.30"	3/8"	.94"	1.26"	6.30"	2	\$506.00	\$354.20
C50A-50SF315-9C	Shrink-fit 9° Bal Cool Prt 1/2 x 3.15"	1/2"	.94"	1.26"	3.15"	1	\$410.00	\$287.00
C50A-50SF512-9C	Shrink-fit 9° Bal Cool Prt 1/2 x 5.12"	1/2"	.94"	1.26"	5.12"	1	\$458.00	\$320.60
C50A-50SF630-9C	Shrink-fit 9° Bal Cool Prt 1/2 x 6.30"	1/2"	.94"	1.26"	6.30"	2	\$506.00	\$354.20
C50A-62SF315-9C	Shrink-fit 9° Bal Cool Prt 5/8 x 3.15"	5/8"	1.06"	1.34"	3.15"	1	\$410.00	\$287.00
C50A-62SF512-9C	Shrink-fit 9° Bal Cool Prt 5/8 x 5.12"	5/8"	1.06"	1.34"	5.12"	1	\$458.00	\$320.60
C50A-62SF630-9C	Shrink-fit 9° Bal Cool Prt 5/8 x 6.30"	5/8"	1.06"	1.34"	6.30"	2	\$506.00	\$354.20
C50A-75SF315-9C	Shrink-fit 9° Bal Cool Prt 3/4 x 3.15"	3/4"	1.30"	1.65"	3.15"	1	\$410.00	\$287.00
C50A-75SF512-9C	Shrink-fit 9° Bal Cool Prt 3/4 x 5.12"	3/4"	1.30"	1.65"	5.12"	1	\$458.00	\$320.60
C50A-75SF630-9C	Shrink-fit 9° Bal Cool Prt 3/4 x 6.30"	3/4"	1.30"	1.65"	6.30"	2	\$506.00	\$354.20
C50A-10SF394-9C	Shrink-fit 9° Bal Cool Prt 1 x 3.94"	1"	1.73"	2.09"	3.94"	1	\$410.00	\$287.00
C50A-10SF512-9C	Shrink-fit 9° Bal Cool Prt 1 x 5.12"	1"	1.73"	2.09"	5.12"	1	\$458.00	\$320.60
C50A-10SF630-9C	Shrink-fit 9° Bal Cool Prt 1 x 6.30"	1"	1.73"	2.09"	6.30"	2	\$506.00	\$354.20
C50A-12SF394-9C	Shrink-fit 9° Bal Cool Prt 1-1/4 x 3.94"	1-1/4"	1.73"	2.09"	3.94"	1	\$410.00	\$287.00
C50A-12SF512-9C	Shrink-fit 9° Bal Cool Prt 1-1/4 x 5.12"	1-1/4"	1.73"	2.09"	5.12"	1	\$458.00	\$320.60
C50A-12SF630-9C	Shrink-fit 9° Bal Cool Prt 1-1/4 x 6.30"	1-1/4"	1.73"	2.09"	6.30"	2	\$506.00	\$354.20

ShrinkFit Holders

6 Extreme Precision Shrinkfit Tools

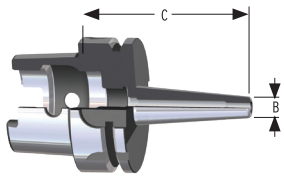

STYLE 1

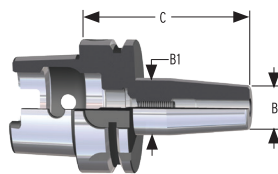

STYLE 2

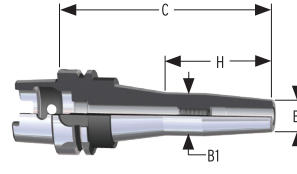

STYLE 3

HSK 63A SHRINKFIT | STANDARD | INCH

Item ID	Item Description	Size	B	B1	C	Style	List Price	Sale Price
H63A-01SF315-9	Shrink-Fit 9 Degree Bal 1/8" X 3.15"	1/8"	0.39"	0.62"	3.15"	2	\$314.00	\$219.80
H63A-18SF315-9	Shrink-Fit 9 Degree Bal 3/16" X 3.15"	3/16"	0.39"	-	3.15"	1	\$314.00	\$219.80
H63A-25SF315-9	Shrink-Fit 9 Degree Bal 1/4" X 3.15"	1/4"	0.83	1.06"	3.15"	2	\$290.00	\$203.00
H63A-25SF630-9	Shrink-Fit 9 Degree Bal 1/4" X 6.30"	1/4"	.83"	1.06"	6.30"	2	\$404.00	\$282.80
H63A-31SF315-9	Shrink-Fit 9 Degree Bal 5/16" X 3.15"	5/16"	.83"	1.06"	3.15"	2	\$290.00	\$203.00
H63A-31SF630-9	Shrink-Fit 9 Degree Bal 5/16" X 6.30"	5/16"	.83"	1.06"	6.30"	3	\$380.00	\$266.00
H63A-38SF335-9	Shrink-Fit 9 Degree Bal 3/8" X 3.35"	3/8"	0.94"	1.26"	3.35"	2	\$290.00	\$203.00
H63A-38SF630-9	Shrink-Fit 9 Degree Bal 3/8" X 6.30"	3/8"	0.94"	1.26"	6.30"	3	\$404.00	\$282.80
H63A-50SF354-9	Shrink-Fit 9 Degree Bal 1/2" X 3.54"	1/2"	0.94"	1.26"	3.54"	2	\$290.00	\$203.00
H63A-50SF630-9	Shrink-Fit 9 Degree Bal 1/2" X 6.30"	1/2"	0.94"	1.26"	6.30"	3	\$404.00	\$282.80
H63A-62SF374-9	Shrink-Fit 9 Degree Bal 5/8" X 3.74"	5/8"	1.06"	1.34"	3.74"	2	\$290.00	\$203.00
H63A-62SF630-9	Shrink-Fit 9 Degree Bal 5/8" X 6.30"	5/8"	1.06"	1.34"	6.30"	3	\$404.00	\$282.80
H63A-75SF394-9	Shrink-Fit 9 Degree Bal 3/4" X 3.94"	3/4"	1.30"	1.65"	3.94"	2	\$290.00	\$203.00
H63A-75SF630-9	Shrink-Fit 9 Degree Bal 3/4" X 6.30"	3/4"	1.30"	1.65"	6.30"	2	\$404.00	\$282.80
H63A-10SF453-9	Shrink-Fit 9 Degree Bal 1" X 4.53"	1"	1.73"	2.09"	4.53"	2	\$290.00	\$203.00
H63A-10SF630-9	Shrink-Fit 9 Degree Bal 1" X 6.30"	1"	1.73"	2.09"	6.30"	2	\$404.00	\$282.80
H63A-12SF472-9	Shrink-Fit 9 Degree Bal 1 1/4" X 4.72"	1-1/4"	1.73"	2.09"	4.72"	2	\$290.00	\$203.00
H63A-12SF630-9	Shrink-Fit 9 Degree Bal 1 1/4" X 6.30"	1-1/4"	1.73"	2.09"	6.30"	2	\$404.00	\$282.80

HSK 63A SHRINKFIT | STANDARD | METRIC

Item ID	Item Description	Size	B	B1	C	Style	List Price	Sale Price
H63A-M04SF80-9	Shrink-Fit 9 Degree Bal 4 X 80mm	4 mm	10 mm	-	80 mm	1	\$314.00	\$219.80
H63A-M06SF130-9	Shrink-Fit 9 Degree Bal 6 X 130mm	6 mm	21 mm	27 mm	130 mm	2	\$404.00	\$282.80
H63A-M06SF160-9	Shrink-Fit 9 Degree Bal 6 X 160mm	6 mm	21 mm	27 mm	160 mm	3	\$404.00	\$282.80
H63A-M06SF80-9	Shrink-Fit 9 Degree Bal 6 X 80mm	6 mm	21 mm	27 mm	80 mm	2	\$290.00	\$203.00
H63A-M08SF130-9	Shrink-Fit 9 Degree Bal 8 X 130mm	8 mm	21 mm	27 mm	130 mm	3	\$404.00	\$282.80
H63A-M08SF160-9	Shrink-Fit 9 Degree Bal 8 X 160mm	8 mm	21 mm	27 mm	160 mm	3	\$404.00	\$282.80
H63A-M08SF80-9	Shrink-Fit 9 Degree Bal 8 X 80mm	8 mm	21 mm	27 mm	80 mm	2	\$404.00	\$282.80
H63A-M10SF130-9	Shrink-Fit 9 Degree Bal 10 X 130mm	10 mm	24 mm	32 mm	130 mm	2	\$404.00	\$282.80
H63A-M10SF160-9	Shrink-Fit 9 Degree Bal 10 X 160mm	10 mm	24 mm	32 mm	160 mm	2	\$404.00	\$282.80
H63A-M10SF85-9	Shrink-Fit 9 Degree Bal 10 X 85mm	10 mm	24 mm	32 mm	85 mm	2	\$295.00	\$206.50
H63A-M12SF130-9	Shrink-Fit 9 Degree Bal 12 X 130mm	12 mm	24 mm	32 mm	130 mm	2	\$404.00	\$282.80
H63A-M12SF160-9	Shrink-Fit 9 Degree Bal 12 X 160mm	12 mm	24 mm	32 mm	160 mm	2	\$404.00	\$282.80
H63A-M12SF90-9	Shrink-Fit 9 Degree Bal 12 X 90mm	12 mm	24 mm	32 mm	90mm	2	\$290.00	\$203.00
H63A-M16SF130-9	Shrink-Fit 9 Degree Bal 16 X 130mm	16 mm	27 mm	34 mm	130 mm	3	\$404.00	\$282.80
H63A-M16SF160-9	Shrink-Fit 9 Degree Bal 16 X 160mm	16 mm	27 mm	34 mm	160 mm	3	\$404.00	\$282.80
H63A-M16SF95-9	Shrink-Fit 9 Degree Bal 16 X 95mm	16 mm	27 mm	34 mm	95 mm	2	\$290.00	\$203.00
H63A-M20SF100-9	Shrink-Fit 9 Degree Bal 20 X 100mm	20 mm	27 mm	42 mm	100 mm	2	\$290.00	\$203.00
H63A-M20SF160-9	Shrink-Fit 9 Degree Bal 20 X 160mm	20 mm	27 mm	42 mm	160 mm	2	\$404.00	\$282.80
H63A-M25SF115-9	Shrink-Fit 9 Degree Bal 25 X 115mm	25 mm	44 mm	53 mm	115 mm	2	\$290.00	\$203.00
H63A-M25SF160-9	Shrink-Fit 9 Degree Bal 25 X 160mm	25 mm	44 mm	53 mm	160 mm	2	\$404.00	\$282.80
H63A-M32SF120-9	Shrink-Fit 9 Degree Bal 32 X 120mm	32 mm	44 mm	53 mm	120 mm	2	\$286.00	\$200.20
H63A-M32SF160-9	Shrink-Fit 9 Degree Bal 32 X 160mm	32 mm	44 mm	53 mm	160 mm	2	\$404.00	\$282.80

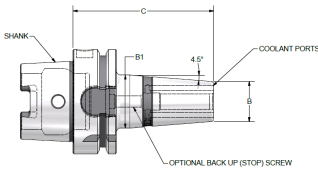

Style 1

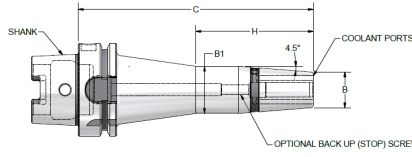

Style 2

HSK 63A SHRINKFIT | COOLANT PORTED | INCH

*Style 3: No Coolant Ports

Item ID	Item Description	Size	B	B1	C	Style	List Price	Sale Price
H63A-25SF315-9C	Shrink-fit 9° Bal Cool Prt 1/4"X 3.15"	1/4"	0.83	1.06"	3.15"	2	\$290.00	\$203.00
H63A-25SF630-9C	Shrink-fit 9° Bal Cool Prt 1/4"X 6.30"	1/4"	.83"	1.06"	6.30"	2	\$404.00	\$282.80
H63A-31SF315-9C	Shrink-fit 9° Bal Cool Prt 5/16"X 3.15"	5/16"	.83"	1.06"	3.15"	2	\$290.00	\$203.00
H63A-31SF630-9C	Shrink-fit 9° Bal Cool Prt 5/16"X 6.30"	5/16"	.83"	1.06"	6.30"	*3	\$380.00	\$266.00
H63A-38SF335-9C	Shrink-fit 9° Bal Cool Prt 3/8"X 3.35"	3/8"	0.94"	1.26"	3.35"	2	\$290.00	\$203.00
H63A-38SF630-9C	Shrink-fit 9° Bal Cool Prt 3/8"X 6.30"	3/8"	0.94"	1.26"	6.30"	*3	\$404.00	\$282.80
H63A-50SF354-9C	Shrink-fit 9° Bal Cool Prt 1/2"X 3.54"	1/2"	0.94"	1.26"	3.54"	2	\$290.00	\$203.00
H63A-50SF630-9C	SShrink-fit 9° Bal Cool Prt 1/2"X 6.30"	1/2"	0.94"	1.26"	6.30"	*3	\$404.00	\$282.80
H63A-62SF374-9C	Shrink-fit 9° Bal Cool Prt 5/8"X 3.74"	5/8"	1.06"	1.34"	3.74"	2	\$290.00	\$203.00
H63A-62SF630-9C	Shrink-fit 9° Bal Cool Prt 5/8"X 6.30"	5/8"	1.06"	1.34"	6.30"	*3	\$404.00	\$282.80
H63A-75SF394-9C	Shrink-fit 9° Bal Cool Prt 3/4"X 3.94"	3/4"	1.30"	1.65"	3.94"	2	\$290.00	\$203.00
H63A-75SF630-9C	Shrink-fit 9° Bal Cool Prt 3/4"X 6.30"	3/4"	1.30"	1.65"	6.30"	2	\$404.00	\$282.80
H63A-10SF453-9C	Shrink-fit 9° Bal Cool Prt 1" X 4.53"	1"	1.73"	2.09"	4.53"	2	\$290.00	\$203.00
H63A-10SF630-9C	Shrink-fit 9° Bal Cool Prt 1" X 6.30"	1"	1.73"	2.09"	6.30"	2	\$404.00	\$282.80
H63A-12SF472-9C	Shrink-fit 9° Bal Cool Prt 1 1/4" X 4.72"	1-1/4"	1.73"	2.09"	4.72"	2	\$290.00	\$203.00
H63A-12SF630-9C	Shrink-fit 9° Bal Cool Prt 1 1/4" X 6.30"	1-1/4"	1.73"	2.09"	6.30"	2	\$404.00	\$282.80

HSK 63A SHRINKFIT | COOLANT PORTED | METRIC

Item ID	Item Description	Size	B	B1	C	Style	List Price	Sale Price
H63A-M06SF80-9C	Shrink-fit 9° Bal Cool Prt 6 x 80mm	6 mm	21 mm	27 mm	80mm	1	\$280.00	\$196.00
H63A-M06SF130-9C	Shrink-fit 9° Bal Cool Prt 6 x 130mm	6 mm	21 mm	27 mm	130mm	1	\$372.00	\$260.40
H63A-M06SF160-9C	Shrink-fit 9° Bal Cool Prt 6 x 160mm	6 mm	21 mm	27 mm	160mm	2	\$408.00	\$285.60
H63A-M08SF80-9C	Shrink-fit 9° Bal Cool Prt 8 x 80mm	8 mm	21 MM	27 mm	80mm	1	\$280.00	\$196.00
H63A-M08SF130-9C	Shrink-fit 9° Bal Cool Prt 8 x 130mm	8 mm	21 mm	27 mm	130mm	1	\$372.00	\$260.40
H63A-M08SF160-9C	Shrink-fit 9° Bal Cool Prt 8 x 160mm	8 mm	21 mm	27 mm	160mm	2	\$408.00	\$285.60
H63A-M10SF85-9C	Shrink-fit 9° Bal Cool Prt 10 x 85mm	10 mm	24 mm	32 mm	85mm	1	\$280.00	\$196.00
H63A-M10SF130-9C	Shrink-fit 9° Bal Cool Prt 10 x 130mm	10 mm	24 mm	32 mm	130mm	1	\$372.00	\$260.40
H63A-M10SF160-9C	Shrink-fit 9° Bal Cool Prt 10 x 160mm	10 mm	24 mm	32 mm	160mm	2	\$408.00	\$285.60
H63A-M12SF90-9C	Shrink-fit 9° Bal Cool Prt 12 x 90mm	12 mm	24 mm	32 mm	90mm	1	\$280.00	\$196.00
H63A-M12SF130-9C	Shrink-fit 9° Bal Cool Prt 12 x 130mm	12 mm	24 mm	32 mm	130mm	1	\$372.00	\$260.40
H63A-M12SF160-9C	Shrink-fit 9° Bal Cool Prt 12 x 160mm	12 mm	24 mm	32 mm	160mm	2	\$408.00	\$285.60
H63A-M16SF95-9C	Shrink-fit 9° Bal Cool Prt 16 x 95mm	16 mm	27 mm	34 mm	95mm	1	\$280.00	\$196.00
H63A-M16SF130-9C	Shrink-fit 9° Bal Cool Prt 16 x 130mm	16 mm	27 mm	34 mm	130mm	1	\$372.00	\$260.40
H63A-M16SF160-9C	Shrink-fit 9° Bal Cool Prt 16 x 160mm	16 mm	27 mm	34 mm	160mm	2	\$408.00	\$285.60
H63A-M20SF100-9C	Shrink-fit 9° Bal Cool Prt 20 x 100mm	20 mm	27 mm	42 mm	100mm	1	\$372.00	\$260.40
H63A-M20SF130-9C	Shrink-fit 9° Bal Cool Prt 20 x 130mm	20 mm	27 mm	42 mm	130mm	1	\$408.00	\$285.60
H63A-M20SF160-9C	Shrink-fit 9° Bal Cool Prt 20 x 160mm	20 mm	27 mm	42 mm	160mm	2	\$280.00	\$196.00
H63A-M25SF115-9C	Shrink-fit 9° Bal Cool Prt 25 x 115mm	25 mm	44 mm	53 mm	115mm	1	\$280.00	\$196.00
H63A-M25SF130-9C	Shrink-fit 9° Bal Cool Prt 25 x 130mm	25 mm	44 mm	53 mm	130mm	1	\$372.00	\$260.40
H63A-M25SF160-9C	Shrink-fit 9° Bal Cool Prt 25 x 160mm	25 mm	44 mm	53 mm	160mm	2	\$408.00	\$285.60
H63A-M32SF120-9C	Shrink-fit 9° Bal Cool Prt 32 x 120mm	32 mm	44 mm	53 mm	120mm	2	\$280.00	\$196.00
H63A-M32SF160-9C	Shrink-fit 9° Bal Cool Prt 32 x 160mm	32 mm	44 mm	53 mm	160mm	1	\$408.00	\$285.60

ShrinkFit Holders

8 Extreme Precision Shrinkfit Tools

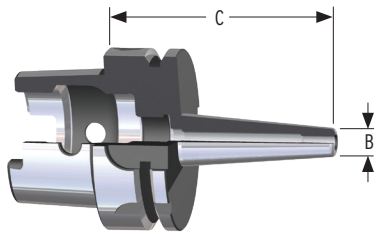

STYLE 1

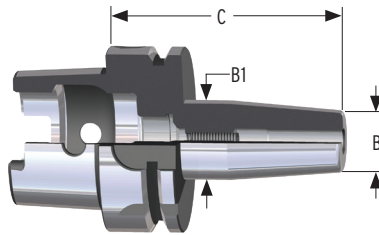

STYLE 2

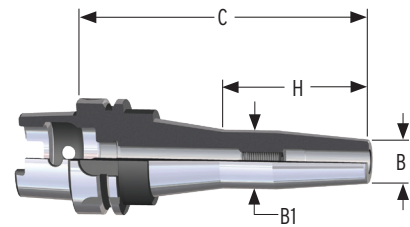

STYLE 3

HSK 100A SHRINKFIT | STANDARD | INCH

Item ID	Item Description	Size	B	B1	C	Style	List Price	Sale Price
H100A-25SF335-9	Shrink-Fit 9 Degree Bal 1/4" X 3.35"	1/4"	0.83"	1.06"	3.35"	2	\$458.00	\$320.60
H100A-25SF630-9	Shrink-Fit 9 Degree Bal 1/4" X 6.30"	1/4"	0.83"	1.06"	6.30"	3	\$499.00	\$349.30
H100A-31SF335-9	Shrink-Fit 9 Degree Bal 5/16" X 3.35"	5/16"	0.83"	1.06"	3.35"	2	\$458.00	\$320.60
H100A-31SF630-9	Shrink-Fit 9 Degree Bal 5/16" X 6.30"	5/16"	0.83"	1.06"	6.30"	3	\$499.00	\$349.30
H100A-38SF354-9	Shrink-Fit 9 Degree Bal 3/8" X 3.54"	3/8"	0.94"	1.26"	3.54"	2	\$458.00	\$320.60
H100A-38SF630-9	Shrink-Fit 9 Degree Bal 3/8" X 6.30"	3/8"	0.94"	1.26"	6.30"	3	\$499.00	\$349.30
H100A-50SF374-9	Shrink-Fit 9 Degree Bal 1/2" X 3.74"	1/2"	0.94"	1.26"	3.74"	2	\$458.00	\$320.60
H100A-50SF630-9	Shrink-Fit 9 Degree Bal 1/2" X 6.30"	1/2"	0.94"	1.26"	6.30"	3	\$499.00	\$349.30
H100A-62SF394-9	Shrink-Fit 9 Degree Bal 5/8" X 3.94"	5/8"	1.06"	1.34"	3.94"	2	\$458.00	\$320.60
H100A-62SF630-9	Shrink-Fit 9 Degree Bal 5/8" X 6.30"	5/8"	1.06"	1.34"	6.30"	3	\$499.00	\$349.30
H100A-75SF413-9	Shrink-Fit 9 Degree Bal 3/4" X 4.13"	3/4"	1.30"	1.65"	4.13"	2	\$458.00	\$320.60
H100A-75SF630-9	Shrink-Fit 9 Degree Bal 3/4" X 6.30"	3/4"	1.30"	1.65"	6.30"	3	\$499.00	\$349.30
H100A-10SF453-9	Shrink-Fit 9 Degree Bal 1" X 4.53"	1"	1.73"	2.09"	4.53"	2	\$458.00	\$320.60
H100A-10SF630-9	Shrink-Fit 9 Degree Bal 1" X 6.30"	1"	1.73"	2.09"	6.30"	3	\$499.00	\$349.30
H100A-12SF472-9	Shrink-Fit 9 Degree Bal 1-1/4" X 4.72"	1-1/4"	1.73"	2.09"	4.72"	2	\$458.00	\$320.60
H100A-12SF630-9	Shrink-Fit 9 Degree Bal 1-1/4" X 6.30"	1-1/4"	1.73"	2.09"	6.30"	3	\$499.00	\$349.30

HSK 100A SHRINKFIT | COOLANT PORTED | INCH

Item ID	Item Description	Size	B	B1	C	Style	List Price	Sale Price
H100A-25SF335-9C	Shrink-fit 9° Bal Cool Prt 1/4" x 3.35"	1/4"	0.83"	1.06"	3.35"	2	\$480.00	\$336.00
H100A-25SF630-9C	Shrink-fit 9° Bal Cool Prt 1/4" x 6.30"	1/4"	0.83"	1.06"	6.30"	3	\$618.00	\$432.60
H100A-31SF335-9C	Shrink-fit 9° Bal Cool Prt 5/16" x 3.35"	5/16"	0.83"	1.06"	3.35"	2	\$480.00	\$336.00
H100A-31SF630-9C	Shrink-fit 9° Bal Cool Prt 5/16" x 6.30"	5/16"	0.83"	1.06"	6.30"	3	\$618.00	\$432.60
H100A-38SF354-9C	Shrink-fit 9° Bal Cool Prt 3/8" x 3.54"	3/8"	0.94"	1.26"	3.54"	2	\$480.00	\$336.00
H100A-38SF630-9C	Shrink-fit 9° Bal Cool Prt 3/8" x 6.30"	3/8"	0.94"	1.26"	6.30"	3	\$618.00	\$432.60
H100A-50SF374-9C	Shrink-fit 9° Bal Cool Prt 1/2" X 3.74"	1/2"	0.94"	1.26"	3.74"	2	\$480.00	\$336.00
H100A-50SF630-9C	Shrink-fit 9° Bal Cool Prt 1/2" x 6.30"	1/2"	0.94"	1.26"	6.30"	3	\$618.00	\$432.60
H100A-62SF394-9C	Shrink-fit 9° Bal Cool Prt 5/8" x 3.94"	5/8"	1.06"	1.34"	3.94"	2	\$480.00	\$336.00
H100A-62SF630-9C	Shrink-fit 9° Bal Cool Prt 5/8" x 6.30"	5/8"	1.06"	1.34"	6.30"	3	\$618.00	\$432.60
H100A-75SF413-9C	Shrink-fit 9° Bal Cool Prt 3/4" x 4.13"	3/4"	1.30"	1.65"	4.13"	2	\$480.00	\$336.00
H100A-75SF630-9C	Shrink-fit 9° Bal Cool Prt 3/4" x 6.30"	3/4"	1.30"	1.65"	6.30"	3	\$618.00	\$432.60
H100A-10SF453-9C	Shrink-fit 9° Bal Cool Prt 1" x 4.53"	1"	1.73"	2.09"	4.53"	2	\$480.00	\$336.00
H100A-10SF630-9C	Shrink-fit 9° Bal Cool Prt 1" x 6.30"	1"	1.73"	2.09"	6.30"	3	\$618.00	\$432.60
H100A-12SF472-9C	Shrink-fit 9° Bal Cool Prt 1-1/4" x 4.72"	1-1/4"	1.73"	2.09"	4.72"	2	\$480.00	\$336.00
H100A-12SF630-9C	Shrink-fit 9° Bal Cool Prt 1-1/4" x 6.30"	1-1/4"	1.73"	2.09"	6.30"	3	\$618.00	\$432.60

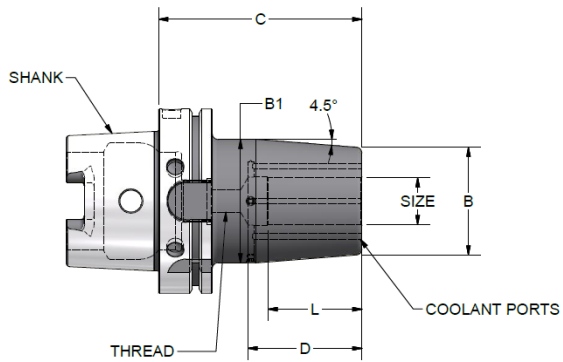

Style 1

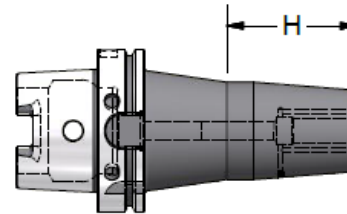

Style 2

HSK 100A SHRINKFIT | HEAVY DUTY | COOLANT PORTED

Item ID	Item Description	Size	B	B1	C	Style	List Price	Sale Price
H100A-38SHD512-9C	Heavy Wall HDSF Cool Prt 3/8" x 5.12"	3/8"	1.50"	1.78"	5.12"	2	\$658.00	\$460.60
H100A-38SHD630-9C	Heavy Wall HDSF Cool Prt 3/8" x 3.94"	3/8"	1.50"	1.78"	6.30"	2	\$723.00	\$506.60
H100A-50SHD374-9C	Heavy Wall HDSF Cool Prt 1/2" x 3.74"	1/2"	1.06"	1.34"	3.74"	1	\$658.00	\$460.60
H100A-50SHD630-9C	Heavy Wall HDSF Cool Prt 1/2" x 6.30"	1/2"	1.50"	1.78"	6.30"	2	\$724.00	\$506.80
H100A-50SHD787-9C	Heavy Wall HDSF Cool Prt 1/2" x 7.87"	1/2"	1.06"	1.34"	7.87"	2	\$788.00	\$551.60
H100A-62SHD394-9C	Heavy Wall HDSF Cool Prt 5/8" x 3.94"	5/8"	1.97"	2.36"	3.94"	1	\$658.00	\$460.60
H100A-62SHD630-9C	Heavy Wall HDSF Cool Prt 5/8" x 6.30"	5/8"	1.97"	2.36"	6.30"	2	\$723.00	\$506.10
H100A-75SHD394-9C	Heavy Wall HDSF Cool Prt 3/4" x 3.94"	3/4"	2.28"	2.64"	3.94"	1	\$658.00	\$460.60
H100A-75SHD413-9C	Heavy Wall HDSF Cool Prt 3/4" x 4.13"	3/4"	2.28"	2.64"	4.13"	1	\$658.00	\$460.60
H100A-75SHD512-9C	Heavy Wall HDSF Cool Prt 3/4" x 5.12"	3/4"	2.28"	2.64"	5.12"	1	\$709.00	\$496.30
H100A-75SHD630-9C	Heavy Wall HDSF Cool Prt 3/4" x 6.30"	3/4"	2.28"	2.64"	6.30"	1	\$723.00	\$506.10
H100A-75SHD787-9C	Heavy Wall HDSF Cool Prt 3/4" x 7.87"	3/4"	2.28"	2.64"	7.87"	1	\$748.00	\$523.60
H100A-10SHD433-9C	Heavy Wall HDSF Cool Prt 1" x 4.33"	1"	2.28"	2.64"	4.33"	1	\$658.00	\$460.60
H100A-10SHD472-9C	Heavy Wall HDSF Cool Prt 1" x 4.72"	1"	2.48"	2.84"	4.72"	1	\$658.00	\$460.60
H100A-10SHD630-9C	Heavy Wall HDSF Cool Prt 1" x 6.30"	1"	2.48"	2.84"	6.30"	1	\$723.00	\$506.10
H100A-10SHD787-9C	Heavy Wall HDSF Cool Prt 1" x 7.87"	1"	2.28"	2.64"	7.87"	1	\$748.00	\$523.60
H100A-12SHD433-9C	Heavy Wall HDSF Cool Prt 1-1/4" x 4.33"	1-1/4"	2.76"	3.07"	4.33"	1	\$658.00	\$460.60
H100A-12SHD472-9C	Heavy Wall HDSF Cool Prt 1-1/4" x 4.72"	1-1/4"	2.76"	3.07"	4.72"	1	\$658.00	\$460.60
H100A-12SHD512-9C	Heavy Wall HDSF Cool Prt 1-1/4" x 5.12"	1-1/4"	2.76"	3.07"	5.12"	1	\$658.00	\$460.60
H100A-12SHD630-9C	Heavy Wall HDSF Cool Prt 1-1/4" x 6.3"	1-1/4"	2.76"	3.07"	6.30"	1	\$723.00	\$506.10
H100A-12SHD787-9C	Heavy Wall HDSF Cool Prt 1-1/4" x 7.87"	1-1/4"	2.76"	3.07"	7.87"	1	\$748.00	\$523.60