

SAVE 15% ON ALL ITEMS

Connect with us on:



ELECTRONIC CALIPERS (STANDARD TYPE, NON-WATERPROOF)



1108-150

INSIZE
ISO17025 CERTIFICATE
AVAILABLE AT
EXTRA CHARGE
(REFER TO BACK COVER)

INSPECTION
CERTIFICATE
TRACEABLE TO NIST

DATA
OUTPUT

- ▶ Resolution .0005"/0.01mm
- ▶ Buttons: on/off, zero, inch/mm
- ▶ Automatic power off, move the digital unit to turn on power
- ▶ Battery CR2032, data output
- ▶ Made of stainless steel
- ▶ Optional accessory: data output cable

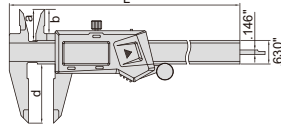

Part No.	Range	Accuracy	L	a	b	d	List Price (\$)	Sale Price (\$)
1108-150*	0-6"/0-150mm	±.0008"	9.291"	.827"	.630"	1.575"	61.30	52.10
1108-200*	0-8"/0-200mm	±.0012"	11.260"	.945"	.748"	1.969"	90.60	77.00
1108-300*	0-12"/0-300mm	±.0012"	15.748"	.984"	.807"	2.362"	137.00	116.00

*Supplied with manufacturer inspection certificate traceable to NIST

ELECTRONIC WATERPROOF CALIPERS



1118-150B

ATTENTION: IT IS NECESSARY TO SET ZERO AFTER POWER ON EACH TIME

IP67
WATERPROOF

ATTENTION: NO
DATA OUTPUT

INSPECTION
CERTIFICATE
TRACEABLE TO NIST

- ▶ Accuracy ±.0015"
- ▶ IP67 dust/waterproof
- ▶ Resolution .0005"/0.01mm
- ▶ Button function: zero, on/off, inch/mm, ABS/REL, hold
- ▶ Battery CR2032
- ▶ Made of stainless steel

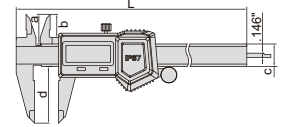

Part No.	Range	L	a	b	c	d	List Price (\$)	Sale Price (\$)
1118-150B*	0-6"/0-150mm	9.291"	.827"	.630"	.630"	1.575"	187.00	159.00
1118-200B*	0-8"/0-200mm	11.260"	.945"	.748"	.630"	1.969"	286.00	243.00
1118-300B*	0-12"/0-300mm	15.748"	.984"	.807"	.669"	2.362"	343.00	292.00

*Supplied with manufacturer inspection certificate traceable to NIST

DIAL CALIPERS

- ▶ Shockproof dial indicator
- ▶ Made of stainless steel



1311-6

SHOCK
PROOF

INSPECTION
CERTIFICATE
TRACEABLE TO NIST

Dial indicator graduation .001"

Part No.	Range	Accuracy	L	a	b	c	d	D	t	List Price (\$)	Sale Price (\$)
1311-6*	0-6"	±.0015"	9.252"	.827"	.650"	.630"	1.575"	1.535" DIA	.256"	61.10	51.90
1311-8*	0-8"	±.0020"	11.339"	.945"	.748"	.630"	1.890"	1.535" DIA	.256"	81.10	68.90
1311-12*	0-12"	±.0020"	16.142"	1.102"	.866"	.787"	2.441"	1.752" DIA	.295"	143.00	122.00

*Supplied with manufacturer inspection certificate traceable to NIST

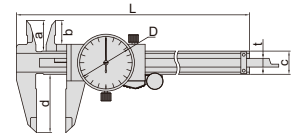

ELECTRONIC CALIPER WITH INTERCHANGEABLE POINTS (NON-WATERPROOF) PART NO. 1526-200



1526-200

DATA
OUTPUT



- ▶ Supplied with 3 pairs of points and zero setting block for external measurement
- ▶ Resolution .0005"/0.01mm
- ▶ Buttons: on/off, set, inch/mm, preset (+, -)
- ▶ Automatic power off, move the digital unit to turn on power
- ▶ Battery CR2032, data output
- ▶ Made of stainless steel
- ▶ Optional accessory: points, depth stop, data output cable

depth stop 6143
(optional)

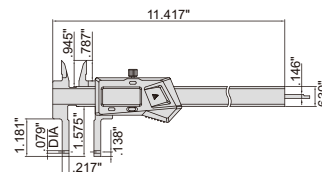

Part No.	List Price (\$)	Sale Price (\$)
1526-200	414.00	352.00

short spherical points (included)



long spherical/flat points (included)



spherical blade points (included)

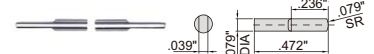

Point	Range	Accuracy	Application
short spherical points	.5-8.5"/12-212mm (internal)	±.0015"	for grooves inside small hole
long spherical/flat points	1-8.8"/24-224mm (internal) 0-7.5"/0-187mm (external)	±.0015"	spherical points for grooves inside hole flat points for external grooves
spherical blade points	1-8.8"/24-224mm (internal) 0-7.5"/0-187mm (external)	±.0015"	for narrow grooves inside hole

DEPTH BASE ATTACHMENT

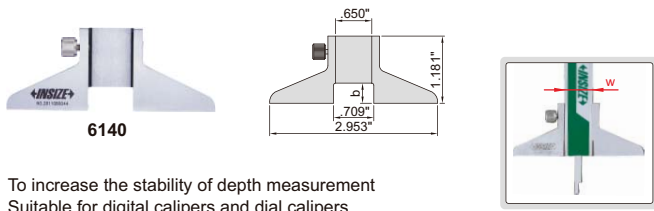

- ▶ To increase the stability of depth measurement
- ▶ Suitable for digital calipers and dial calipers
- ▶ Made of stainless steel

Part No.	Application	b	List Price (\$)	Sale Price (\$)
6140	suitable for calipers with beam width (w) .630"	.354"	22.90	19.50

ELECTRONIC HEIGHT GAGE WITH DRIVING WHEEL

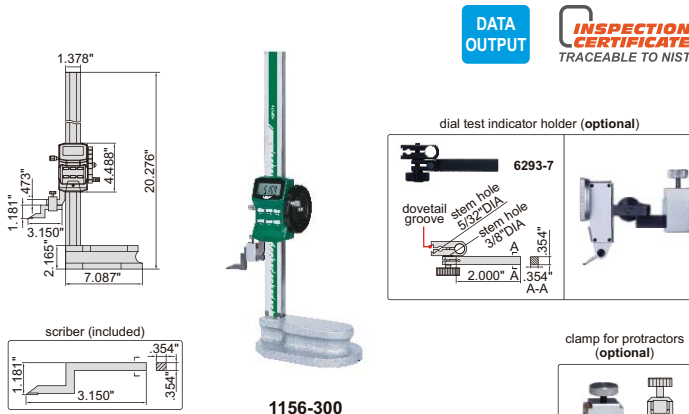

- ▶ Resolution .0005"/0.01mm
- ▶ Buttons: on/off, zero, inch/mm, preset (+, -), hold
- ▶ Automatic power off, move the digital unit to turn on power
- ▶ Carbide tipped scribe
- ▶ Made of stainless steel
- ▶ Battery CR2032, data output
- ▶ Supplied with dust cover
- ▶ Optional accessory: data output cable, dial test indicator holder (part no. 6293-7), clamp for protractors (part no. 2372-CLAMP)

Part No.	Range	Accuracy	List Price (\$)	Sale Price (\$)
1156-300*	0-12"/0-300mm	±.0015"	597.00	507.00

*Supplied with manufacturer inspection certificate traceable to NIST

ELECTRONIC DEPTH GAGE WITH MOUNTING HOLES FOR EXTENSION BASE

DATA OUTPUT



1147-200

- ▶ Resolution .0005"/0.01mm
- ▶ Buttons: on/off, zero, inch/mm
- ▶ Automatic power off, move the digital unit to turn on power
- ▶ Battery CR2032, data output
- ▶ Made of stainless steel
- ▶ Optional accessory: data output cable, extension base

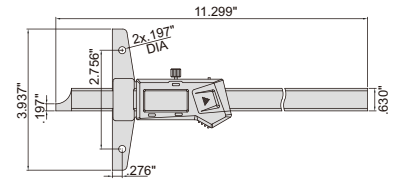

Part No.	Range	Accuracy	List Price (\$)	Sale Price (\$)
1147-200	0-8"/0-200mm	±.0015"	175.00	149.00

ELECTRONIC OUTSIDE MICROMETER (BASIC TYPE)

ATTENTION: NO DATA OUTPUT



3109-25E

- ▶ Resolution .00005"/0.001mm
- ▶ Button functions: on/off, set, inch/mm, ABS/INC
- ▶ No data output, friction thimble
- ▶ LR44 battery, automatic power off
- ▶ Carbide measuring faces
- ▶ Supplied with spherical anvil

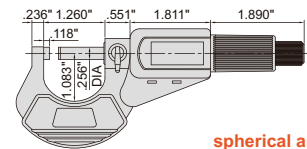

spherical anvil is included

Part No.	Range	Accuracy	List Price (\$)	Sale Price (\$)
3109-25E*	0-1"/0-25mm	±.00010"	113.00	96.10

*Supplied with manufacturer inspection certificate traceable to NIST

OUTSIDE MICROMETERS

- ▶ Graduation .0001"
- ▶ Carbide measuring faces
- ▶ Ratchet stop type
- ▶ Supplied with setting standards (except 0-1")

Individual

Part No.	Range	Accuracy	L	a	b	List Price (\$)	Sale Price (\$)
3203-1A*	0-1"	.00015"	1.260"	.354"	1.102"	39.20	33.30
3203-2A*	1-2"	.00015"	2.244"	.551"	1.496"	43.80	37.20
3203-3A*	2-3"	.00020"	3.228"	.591"	1.929"	48.70	41.40
3203-4A*	3-4"	.00020"	4.213"	.591"	2.362"	54.90	46.70

Set

Part No.	Range	Micrometers included	Packaging	List Price (\$)	Sale Price (\$)
3203-33A*	0-3"	3203-1A, 3203-2A, 3203-3A	blow mould case	116.00	98.60
3203-44A*	0-4"	3203-1A, 3203-2A, 3203-3A, 3203-4A	blow mould case	170.00	145.00
3203-66A*	0-6"	3203-1A, 3203-2A, 3203-3A, 3203-4A, 3203-5A, 3203-6A	blow mould case	300.00	255.00

*Supplied with manufacturer inspection certificate traceable to NIST



3203-2A



3203-44A

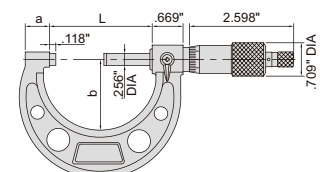

PISTOL GRIP THREE POINT BORE GAGES

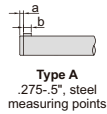
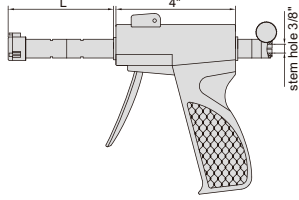

Type A
.275-.5", steel
measuring points



2124-E035
electronic indicator
is optional

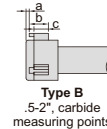

Type B
.5-2", carbide
measuring points



2124-E1
electronic indicator
is optional

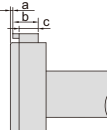

Type C
2-4", carbide
measuring points



2124-E4
electronic indicator
is optional

► Optional accessory: digital indicators (part no. 2108-101EF, resolution .00005"/0.001mm), setting rings (part no. 6312)



Individual

Part No.	Range	Type	Accuracy	Setting ring (included)	Extension rod (included)	L	a	b	c	List Price (\$)	Sale Price (\$)
2124-E035*	.275-.35"	A	.00015"	.275" DIA	4"	2"	.059"	.098"	—	535.00	455.00
2124-E0425*	.35-.425"	A	.00015"	.35" DIA	4"	2"	.059"	.098"	—	524.00	445.00
2124-E05*	.425-.5"	A	.00015"	.5" DIA	4"	2"	.059"	.098"	—	556.00	473.00
2124-E065*	.5-.65"	B	.00015"	.65" DIA	6"	2.6"	.020"	.236"	.177"	562.00	478.00
2124-E08*	.65-.8"	B	.00015"	.65" DIA	6"	2.6"	.020"	.236"	.177"	596.00	507.00
2124-E1*	.8-1"	B	.00015"	1" DIA	6"	3.64"	.020"	.315"	.236"	635.00	540.00
2124-E112*	1-1.2"	B	.00015"	1" DIA	6"	3.64"	.020"	.315"	.236"	677.00	575.00
2124-E16*	1.2-1.6"	B	.00015"	1.6" DIA	6"	3.88"	.020"	.551"	.472"	727.00	618.00
2124-E2*	1.6-2"	B	.00020"	1.6" DIA	6"	3.88"	.020"	.551"	.472"	775.00	659.00
2124-E25*	2-2.5"	C	.00020"	2.5" DIA	6"	4.48"	.020"	.689"	.571"	839.00	713.00
2124-E3*	2.5-3"	C	.00020"	2.5" DIA	6"	4.48"	.020"	.689"	.571"	894.00	760.00
2124-E35*	3-3.5"	C	.00020"	3.5" DIA	6"	4.48"	.020"	.689"	.571"	951.00	808.00
2124-E4*	3.5-4"	C	.00020"	3.5" DIA	6"	4.48"	.020"	.689"	.571"	1013.00	861.00

*Supplied with manufacturer inspection certificate

setting rings are included



extension rods are included



THREE POINTS INTERNAL MICROMETERS



- .275-.5": graduation .0001"
- .5-4": graduation .0002"
- Ratchet stop
- Optional accessory: setting rings (part no. 6313), micrometer stand and clamp (part no. 6301 and 6301-2)



micrometer stand with clamp (optional)

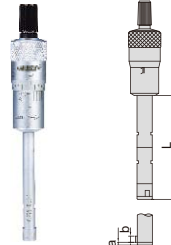

3227-E035

Type A
.275-.5", steel points

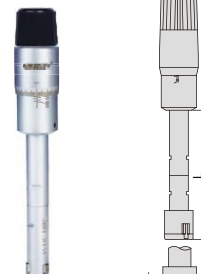

3227-E065

Type B
.5-2", carbide points



3227-E4

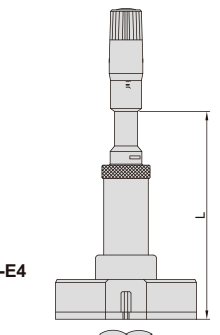

Type C
2-4", carbide points

Individual

Part No.	Range	Type	Accuracy	Setting ring (included)	Extension rod (included)	L	a	b	c	List Price (\$)	Sale Price (\$)
3227-E035*	.275-.35"	A	.00015"	.275" DIA	4"	2.146"	.059"	.098"	—	483.00	411.00
3227-E0425*	.35-.425"	A	.00015"	.35" DIA	4"	2.146"	.059"	.098"	—	483.00	411.00
3227-E05*	.425-.5"	A	.00015"	.5" DIA	4"	2.146"	.059"	.098"	—	483.00	411.00
3227-E065*	.5-.65"	B	.00015"	.65" DIA	6"	3.150"	.020"	.236"	.177"	365.00	310.00
3227-E08*	.65-.8"	B	.00015"	.65" DIA	6"	3.150"	.020"	.236"	.177"	365.00	310.00
3227-E1*	.8-1"	B	.00015"	1" DIA	6"	3.543"	.020"	.315"	.236"	512.00	435.00
3227-E112*	1-1.2"	B	.00015"	1" DIA	6"	3.543"	.020"	.315"	.236"	512.00	435.00
3227-E16*	1.2-1.6"	B	.00015"	1.6" DIA	6"	3.819"	.020"	.551"	.472"	551.00	468.00
3227-E2*	1.6-2"	B	.00020"	1.6" DIA	6"	3.819"	.020"	.551"	.472"	640.00	544.00
3227-E25*	2-2.5"	C	.00020"	2.5" DIA	6"	4.488"	.020"	.689"	.571"	694.00	590.00
3227-E3*	2.5-3"	C	.00020"	2.5" DIA	6"	4.488"	.020"	.689"	.571"	744.00	632.00
3227-E35*	3-3.5"	C	.00020"	3.5" DIA	6"	4.488"	.020"	.689"	.571"	778.00	661.00
3227-E4*	3.5-4"	C	.00020"	3.5" DIA	6"	4.488"	.020"	.689"	.571"	809.00	688.00

setting rings are included



extension rods are included



Set

Part No.	Range	Micrometers included	Setting ring (included)	Extension rod (included)	List Price (\$)	Sale Price (\$)
3227-E053*	.275-.5"	.275-.35", .35-.425", .425-.5"	.275" DIA, .35" DIA, .5" DIA	4"	1349.00	1147.00
3227-E082*	.5-.8"	.5-.65", .65-.8"	.65" DIA	6"	679.00	577.00
3227-E24*	.8-2"	.8-1", 1-1.2", 1.2-1.6", 1.6-2"	1" DIA, 1.6" DIA	6"	1937.00	1646.00
3227-E44*	2-4"	2-2.5", 2.5-3", 3-3.5", 3.5-4"	2.5" DIA, 3.5" DIA	6"	2583.00	2196.00

*Supplied with manufacturer inspection certificate



3227-E24

TELESCOPING GAGE SET



- ▶ 6 gages per set
- ▶ For quick measurement of inside diameter of holes and width of slots
- ▶ Satin chrome finish

Range	L	a	b	c
5/16~1/2"	4.528"	.154" DIA	.114" DIA	.244" DIA
1/2~3/4"	4.528"	.209" DIA	.150" DIA	.244" DIA
3/4~1-1/4"	4.528"	.209" DIA	.150" DIA	.244" DIA
1-1/4~2-1/8"	5.394"	.299" DIA	.240" DIA	.283" DIA
2-1/8~3-1/2"	5.394"	.299" DIA	.240" DIA	.283" DIA
3-1/2~6"	5.394"	.299" DIA	.240" DIA	.283" DIA

4206-1

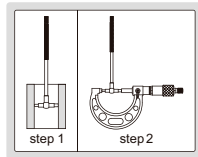

Part No.	Total range	Gages included	List Price (\$)	Sale Price (\$)
4206-1	5/16~6"	5/16~1/2", 1/2~3/4", 3/4~1-1/4", 1-1/4~2-1/8", 2-1/8~3-1/2", 3-1/2~6"	45.80	38.90

BORE GAGES

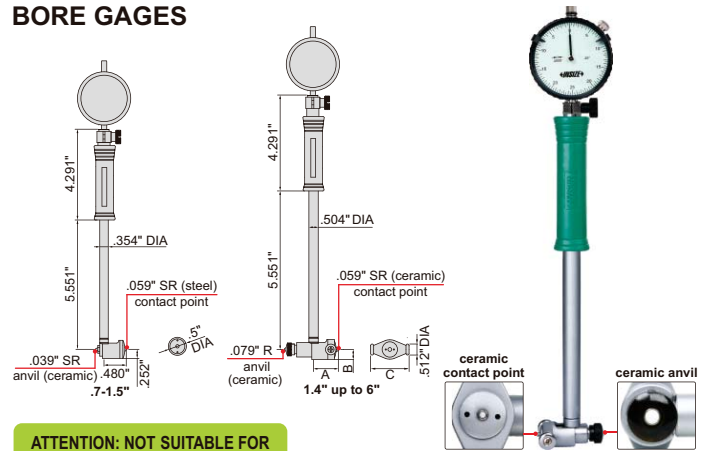

ATTENTION: NOT SUITABLE FOR .00005" OR .0001" DIAL INDICATORS

- ▶ Optional accessory: setting ring (part no. 6313), long handle (part no. 7351)

Range	A	B	C
1.4-2.4"	.866"	.354"	1.063"
2-6"	1.024"	.354"	1.378"

With dial indicator

Part No.	Range	Indicator	Accuracy	Repeatability	List Price (\$)	Sale Price (\$)
2323-15	.7-1.5"	dial indicator range .25" graduation	±.00075"	.00015"	204.00	173.00
2323-24	1.4-2.4"	.0005"	±.0009"	.00015"	186.00	158.00
2323-6	2-6"	.0005"	±.0009"	.00015"	196.00	167.00

BORE GAGE SETS

ATTENTION: NOT SUITABLE FOR .00005" OR .0001" DIAL INDICATORS

- ▶ Repeatability .00015"
- ▶ Dial indicator: range .25", graduation .0005"
- ▶ Optional accessory: setting ring (part no. 6313), long handle (part no. 7351)

packaging (part no. 2824-S3E)



Part No.	Range	Bore gages included	Accuracy	List Price (\$)	Sale Price (\$)
2824-S2E	1.4-6"	① 1.4-2" (dial indicator and handle are not included) ② 2-6"	1.4-2" ±.0009" 2-6" ±.0009"	224.00	190.00
2824-S3E	.7-6"	① .7-1.5" ② 1.4-2.4" (dial indicator is not included) ③ 2-6" (dial indicator is not included)	.7-1.5" ±.00075" 1.4-2.4" ±.0009" 2-6" ±.0009"	511.00	434.00



ELECTRONIC INDICATOR (STANDARD TYPE)

DATA OUTPUT

INSPECTION CERTIFICATE TRACEABLE TO NIST



2112-10E

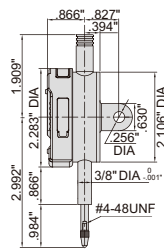

spindle lift knob is included



Part No.	Range	Resolution	List Price (\$)	Sale Price (\$)
2112-10E*	.5"/12.7mm	.0005"/0.01mm	134.00	114.00

*Supplied with manufacturer inspection certificate traceable to NIST

DIAL INDICATOR

INSIZE ISO17025 CERTIFICATE AVAILABLE AT EXTRA CHARGE (REFER TO BACK COVER)



2307-1

- ▶ Graduation .001"
- ▶ Meet ASME B89.1.10M-2001
- ▶ Lug back
- ▶ Supplied with limit pointers and bezel clamp
- ▶ Optional accessory: backs, contact points

INSPECTION CERTIFICATE TRACEABLE TO NIST

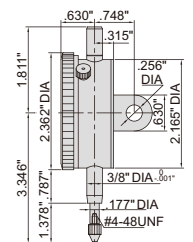

Part No.	Range	Accuracy		Range / rev	Dial reading	List Price (\$)	Sale Price (\$)
		First 2.5 rev	Overall				
2307-1*	1"	±.001"	±.002"	.1"	0-100	36.30	30.90

*Supplied with manufacturer inspection certificate traceable to NIST

DIAL TEST INDICATORS



2380-31

clamps are included

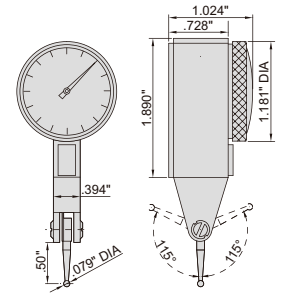

- ▶ Dial reading: 0-15-0
- ▶ Jeweled bearing
- ▶ Carbide contact point
- ▶ Two measuring directions
- ▶ Anti magnetic body
- ▶ Supplied with two clamps: 5/32" DIA and 3/8" DIA
- ▶ Optional accessory: styli

Part No.	Range	Graduation	Accuracy	List Price (\$)	Sale Price (\$)
2380-31 *	.03"	.001"	±.001"	78.00	66.30
2380-35 *	.03"	.0005"	±.0005"	97.20	82.60

* Supplied with manufacturer inspection certificate traceable to NIST

UNIVERSAL MAGNETIC STAND



6210-80E

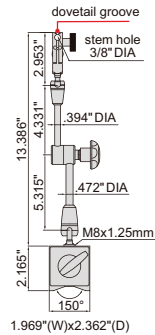

- ▶ For digital/dial indicators and dial test indicator
- ▶ With fine adjustment and dovetail groove

MAGNETIC STAND



6201-60

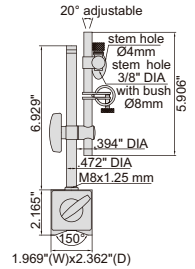

- ▶ Applicable holding stem: 3/8" DIA, Ø8mm, Ø4mm
- ▶ For electronic/dial indicators and dial test indicators

Part No.	Magnetic force	Applicable holding stem	List Price (\$)	Sale Price (\$)
6210-80E	176lbf	3/8" DIA	162.00	138.00

Part No.	Magnetic force	Remark	List Price (\$)	Sale Price (\$)
6201-60	132lbf	with fine adjustment	29.60	25.20

MACHINIST SQUARES WITH WIDE BASE (ECONOMIC TYPE)



4707-100

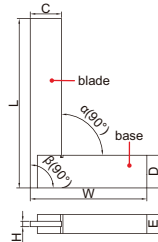

- ▶ DIN875 grade 2
- ▶ Made of carbon steel, no anti-rust treatment, not hardened

ATTENTION: NO ANTI-RUST TREATMENT, NOT HARDENED

ATTENTION: LOW ACCURACY

Part No.	Size (LxW)	Squareness		C	D	H	E	List Price (\$)	Sale Price (\$)
		Inside (α)	Outside (β)						
4707-100	3.9x2.8"	1.10mil	1.18mil	.748"	.748"	.118"	.472"	21.70	18.40
4707-150	6x4"	1.30mil	1.38mil	.984"	.984"	.118"	.630"	30.70	26.10
4707-200	8x5"	1.46mil	1.58mil	1.181"	1.260"	.157"	.630"	53.50	45.50
4707-300	12x8"	1.85mil	1.97mil	1.260"	1.260"	.157"	.748"	80.20	68.20

UNIVERSAL PROTRACTOR

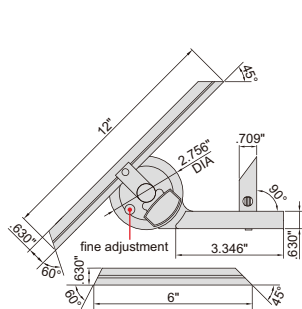

6" blade is included



2372-360

clamp for height gages (optional)



- ▶ Graduation 5', accuracy ±5'
- ▶ Parallax-free reading
- ▶ Made of stainless steel
- ▶ Optional accessory: clamp (part no. 2372-CLAMP), suitable for height gages 1156, 1351 and 1250

Part No.	Range	List Price (\$)	Sale Price (\$)
2372-360	0-360°	112.00	95.20

FEELER GAGE



4608-31

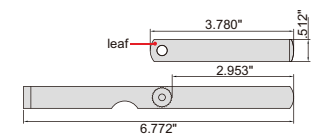

- ▶ .010" is made of brass, others are made of hardened alloy steel
- ▶ Each blade is marked with inch/metric size

Thickness of leaves included	Accuracy
.010" (brass)	±.00039"
.0015", .002"	±.0002"
.0025", .003", .004", .005", .006", .007"	±.00028"
.008", .009"	±.00035"
.010", .011"	±.00039"
.012", .013"	±.00047"
.014", .015"	±.00051"
.016", .017"	±.00055"
.018", .019"	±.00059"
.020", .021"	±.00067"
.022", .023"	±.00071"
.024", .025", .026"	±.00075"
.028"	±.00091"
.030"	±.00094"
.032", .035"	±.00102"

Part No.	Range	Quantity of Leaves	List Price (\$)	Sale Price (\$)
4608-31	.0015"~.035"	32	10.60	9.01

3-PIECE MEASURING TOOL SET

- Includes:
 - 1) Electronic caliper, range 0-6"/0-150mm, resolution .0005"/0.01mm (part no. 1108-150)
 - 2) Outside micrometer, range 0-1", graduation .0001" (part no. 3202-1)
 - 3) Steel rule, 6"/150mm (part no. 7110-150)



5003-1E

Part No.	List Price (\$)	Sale Price (\$)
5003-1E	106.00	90.10

3-PIECE MEASURING TOOL SET

- Includes:
 - 1) Dial caliper, range 0-6", graduation .001" (part no. 1311-6)
 - 2) Outside micrometer, range 0-1", graduation .0001" (part no. 3202-1)
 - 3) Steel rule, 6"/150mm (part no. 7110-150)

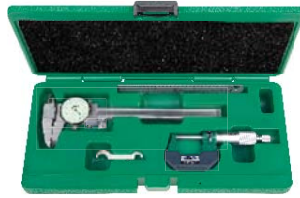

5003-1

Part No.	List Price (\$)	Sale Price (\$)
5003-1	113.00	96.10

2-PIECE MEASURING TOOL SET

- Includes:
 - 1) Electronic caliper, range 0-6"/0-150mm, resolution .0005"/0.01mm (part no. 1108-150)
 - 2) Electronic outside micrometer, range 0-1"/0-25mm, resolution .00005"/0.001mm (part no. 3109-25B)



5022

Part No.	List Price (\$)	Sale Price (\$)
5022	191.00	162.00

ELECTRONIC EDGE FINDERS

- Accuracy .0002"
- The shank is electrically conducted to the metal workpiece through the chuck and table, when the ball touches the workpiece
- Not suitable for rotary use
- Hardened shank and contact ball

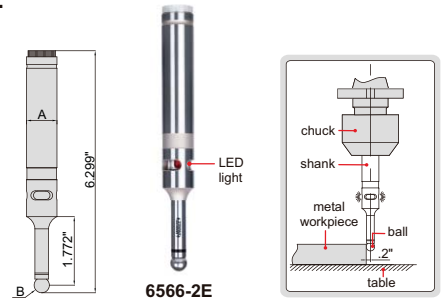

6566-2E

Part No.	Shank (A)	Contact ball (B)	Battery	List Price (\$)	Sale Price (\$)
6566-2E	3/4" DIA	.4" DIA	23AE, 12Vx1 pc	134.00	114.00

VISION MEASURING SYSTEM

SPECIFICATION

Part No.	ISD-V150A	ISD-V250A	ISD-V300A
List Price (\$)	12265.00	13657.00	14918.00
Sale Price (\$)	10425.00	11608.00	12680.00
Measuring range (X*Y*Z)	6x4x8"	10x6x8"	12x8x8"
Stage size	13.94x8.98"	17.72x11.02"	19.69x12.99"
Glass stage size	8.27x6.30"	12.05x7.72"	13.78x9.84"
Resolution of X/Y/Z axis	.00002"		
Accuracy of X/Y axis	≤(98.4+10L)µin L is the measuring length in inch		
Repeatability of X/Y axis	.00008"		
Objective	0.7X~4.5X (zoom)		
Working distance	3.62"		
Magnification	33X~195X (on 19" monitor)		
Camera	1/3" color CCD, 0.3M pixel		
Illumination	surface and contour with adjustable LED		
Max. height of workpiece	6.30"		
Max. weight of workpiece	44lb		
Operation system	Windows 7/8/10		
Drive method	manual		
Power supply	110/220V, 50/60Hz		
Dimension (L*W*H)	22.05x21.26x33.46"	29.92x23.62x35.43"	29.92x23.62x35.43"
Weight	220lb	264lb	308lb

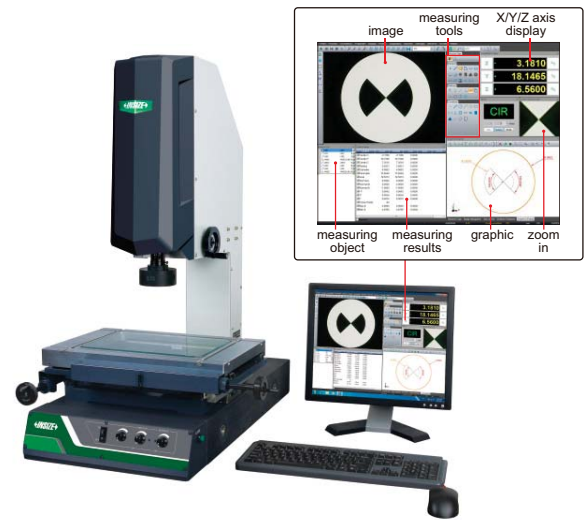

ISD-V250A

STANDARD DELIVERY

Main unit	1 pc
Video card with dongle	1 pc
Software disc	1 pc
Calibration glass chart	1 pc
Laser positioner	1 pc
Clay	1 pc
Foot switch	1 pc
Anti-dust cover	1 pc

OPTIONAL ACCESSORY

0.5X auxiliary objective	Part No. ISD-V-OB05X Working distance: 6.89" Magnification: 16.5~97.5X (on 19" monitor)
2X auxiliary objective	Part No. ISD-V-OB2X Working distance: 1.42" Magnification: 66~390X (on 19" monitor)
Probe	Part No. ISD-V-PROBE includes Ø2mm/.079" DIA and Ø3mm/.118" DIA styli, Ø25mm/.984" calibration ball
Lens with coaxial light	Part No. ISD-V-LENS (must be installed in factory)

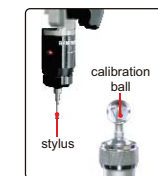

probe (optional), includes Ø2mm/.079" DIA and Ø3mm/.118" DIA styli, Ø25mm/.984" calibration ball, measuring accuracy is .0004"



software CD (included)



lens with coaxial light (optional, must be installed in factory)

CNC VISION MEASURING SYSTEM



- Automatic edge-detection, focus, measuring, contour scanning, calibration, etc.
- Servo motors for X, Y, Z axis
- SPC function for large quantity measurement

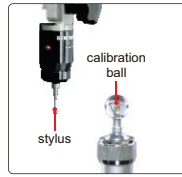

probe (optional), includes Ø2mm/.079" DIA and Ø3mm/.118" DIA styli, Ø25mm/.984" calibration ball, measuring accuracy is .0004"

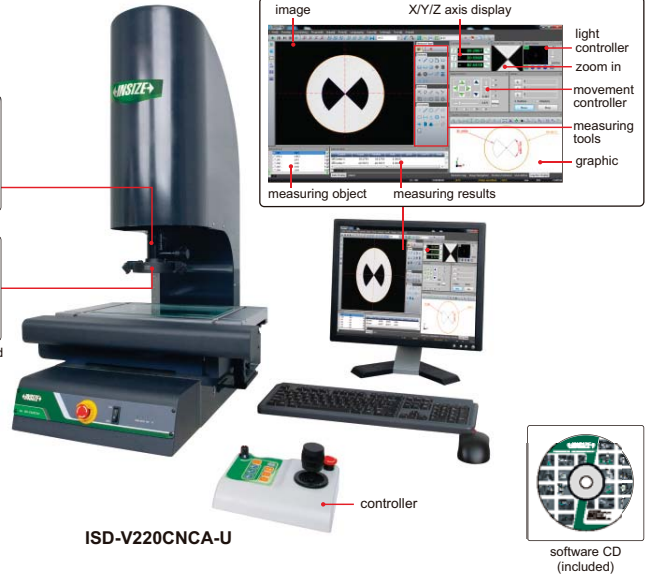

SPECIFICATION

Part No.	ISD-V220CNCA **	ISD-V270CNCA **	ISD-V370CNCA **
List Price (\$)	29803.00	32357.00	39826.00
Sale Price (\$)	25332.00	27503.00	33852.00
Measuring range (X*Y*Z)	8.66×4.72×5.90"	10.63×6.69×5.90"	14.57×10.63×5.90"
Stage size	17.72×11.02"	19.69×12.99"	23.86×18.35"
Glass stage size	12.05×7.72"	13.78×9.84"	17.72×13.78"
Resolution of X/Y/Z axis	.00002"		
Accuracy of X/Y axis	≤(98.4+10L)µin (L is the measuring length in inch)		
Repeatability of X/Y axis	.00008"		
Objective	0.7X~4.5X (zoom)		
Working distance	3.62"		
Magnification	20X~128X (on 19.5" monitor)		
Camera	1/2" color CCD, 0.4M pixel		
Illumination	surface	coaxial light, programmable segmented ring light	
	contour	adjustable LED	
View field (diagonal length)	.07~.44"		
Max. height of workpiece	6.30"		
Max. weight of workpiece	66lb		
Operation system	Windows 7/8/10		
Drive method	Automatic		
Power supply	110V, 50/60Hz **		
Dimension (L×W×H)	29.92×23.62×35.43"	29.92×23.62×35.43"	38.19×26.38×37.01"
Weight	322lb	370lb	586lb

STANDARD DELIVERY

Main unit	1 pc
Video card with dongle	1 pc
Software disc	1 pc
Len with coaxial light	1 pc

STANDARD DELIVERY

Controller	1 pc
Calibration glass chart	1 pc
Laser positioner	1 pc
Clay	1 pc
Anti-dust cover	1 pc

OPTIONAL ACCESSORY

0.5X auxiliary objective	Part No. ISD-V-OB05X Working distance: 6.89" Magnification: 10~64X (on 19.5" monitor)
2X auxiliary objective	Part No. ISD-V-OB2X Working distance: 1.42" Magnification: 66~390X (on 19.5" monitor)
Probe	Part No. ISD-V-PROBE includes Ø2mm/.079" DIA and Ø3mm/.118" DIA styli, Ø25mm/.984" calibration ball

ELECTRONIC LEVEL AND SLOPE METER

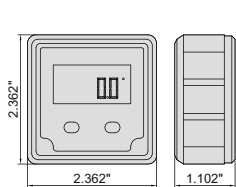

2170-1

BACKLIGHT

MAGNETIC BOTTOM
ABSOLUTE LEVEL

WORKING TEMPERATURE
23°F~122°F

DISPLAY FLIPS OVER WHEN THE BOTTOM FACES UP

- Can be used as level and slope meter, measure the angle of two separate surfaces
- Aluminum frame, magnetic bottom
- The display flips over when the bottom faces up
- The backlight is on automatically when in use, and automatically off in 15 minutes after use
- The sea level is permanently set inside the chip, zero setting is not needed when battery is replaced
- Buttons: ON/OFF, ZERO, absolute and incremental measurement
- One AAA battery, automatic power off in 5 minutes

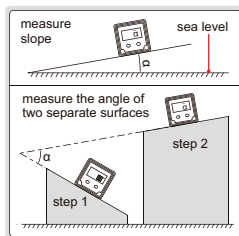

Part No.	Range	Resolution	Accuracy	List Price (\$)	Sale Price (\$)
2170-1	4x90°	0.1° (=.021in/ft)	at 0° and 90°: ±0.1°; others: ±0.2°	97.70	83.00

ELECTRONIC LEVEL AND SLOPE METER



2179-360

BACKLIGHT

IP54 WATERPROOF

ABSOLUTE LEVEL

WORKING TEMPERATURE
23°F~122°F

BUZZER ALARM
AT 0° AND 90°

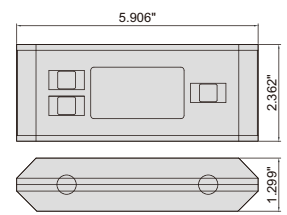

- IP 54 dust/waterproof
- Used as level and slope meter to measure the angle of two separate surfaces
- Aluminum frame
- Magnetic bottom with V-groove for plane and cylinder
- The sea level is permanently set inside the chip, zero setting is not needed when battery is replaced
- Buttons: ON/OFF, absolute and incremental measurement, keep the reading, buzzer alarm, unit (mm/m, %, in/ft), conversion, backlight
- Two AAA batteries, automatic power off

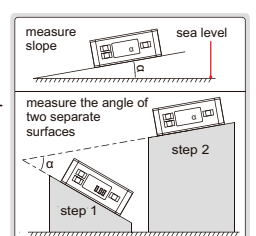

Part No.	Range	Resolution	Accuracy	List Price (\$)	Sale Price (\$)
2179-360	0-360° (90°x4)	0.05° (=.00625in/ft)	at 0° and 90°: ±0.1°; others: ±0.2°	167.00	142.00

MANUAL ROCKWELL HARDNESS TESTER
PART NO. ISH-R150



SPECIFICATION

List Price (\$)	2971.00
Sale Price (\$)	2525.00
Hardness scale	HRA, HRB, HRC, HRD, HRF, HRG
Preliminary test force	98N/10kgf
Test force	588N/60kgf, 980N/100kgf, 1471N/150kgf
Display	analogue
Stage elevation	manual
Load control	manual
Min. reading	0.5HR
Max. workpiece height	6.69"
Max. workpiece depth	6.50" (from the center of indenter)
Dimension	20.47×6.30×27.56"
Weight	132lb

STANDARD DELIVERY

Main unit	1 pc
2.36" DIA flat anvil	1 pc
5.91" DIA flat anvil	1 pc
V-type anvil	1 pc
Diamond indenter	1 pc
1/16" DIA carbide ball indenter	1 pc
Hardness test block HRC20-30	1 pc
Hardness test block HRC60-65	1 pc
Hardness test block HRB88-95	1 pc
Anti-dust cover	1 pc



OPTIONAL ACCESSORY

Hardness test block HRC20-30	ISH-BHRC1
Hardness test block HRC60-65	ISH-BHRC3
Hardness test block HRB88-95	ISH-BHRB
Small V-type anvil	ISH-SMALL ANVIL

DIGITAL MEASURING MICROSCOPE (WITH DISPLAY)

TAKE PICTURES

MEASUREMENT

BUILT-IN SOFTWARE WITHOUT COMPUTER

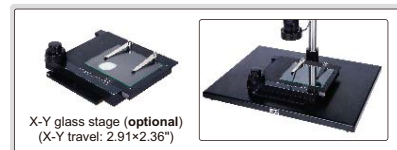

- ▶ 1080P high-definition image
- ▶ Built-in software without computer, operation by mouse
- ▶ Take pictures, saved to USB flash disk
- ▶ Measurement results can be output to Excel
- ▶ Automatic white balance and exposure
- ▶ Brightness, contrast ratio, gain are adjustable

SPECIFICATION

Part No.	ISM-DL301-U (with contour illumination)	
List Price (\$)	3366.00	
Sale Price (\$)	2861.00	
Magnification	15X~100X	
Sensor	1/2" CMOS	
Pixel	2M	
Resolution	1920×1080	
Frame rate	60fps	
Output	HDMI	
Power supply	power adapter and 110V, 50/60Hz	
Dimension (L×W×H)	22.44×11.81×16.93"	
Weight	14.44lb	

Part No.	List Price (\$)	Sale Price (\$)
ISM-DL-STAGE	222.00	189.00

STANDARD DELIVERY

Main unit	1 pc
0.5X camera adapter	1 pc
1X auxiliary objective	1 pc
Calibration plate	1 pc
16G USB flash disk	1 pc
White/black plate	1 pc
Mouse	1 pc
HDMI cable	1 pc
Power adapter	2 pcs

OPTIONAL ACCESSORY

1X camera adapter	ISM-DL-CA1X
2X auxiliary objective	ISM-DL-OB2X
X-Y glass stage (travel: 2.91×2.36")	ISM-DL-STAGE
X-Y metal stage	ISM-DL-STAGE1
LED auxiliary illumination	ISM-DL-LED
Coaxial light illumination	ISM-DL-COAXIAL
Auxiliary objective lens	

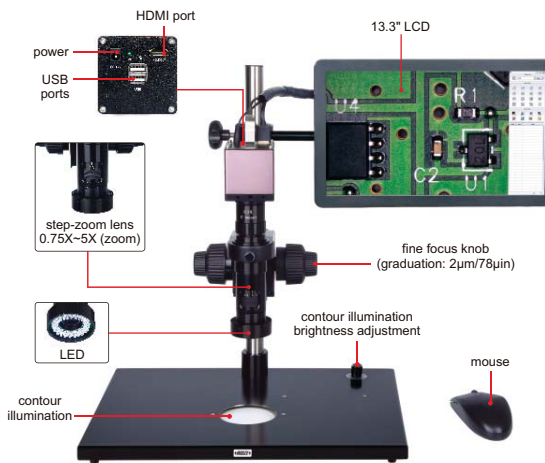

ISM-DL301-U (with contour illumination)

MEASURING ACCURACY

Magnification	Measuring accuracy*
15X	±.00031"
30X	±.00024"
50X	±.00024"
80X	±.00016"
100X	±.00016"
>100X	±.00016"

*When measuring the contour of workpieces, please select ISM-DL301-U to ensure accuracy.

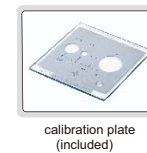

MAGNIFICATION, FOCUS DISTANCE AND VIEW FIELD

Auxiliary Objective	Specification	Camera adapter	
		0.5X (included)	1X (optional)
1X (included)	Magnification	15~100X	30~200X
	Focus distance	2.76±.08"	2.76±.08"
	View filed	.63×.43"~.1×.06"	.31×.21"~.05×.03"
2X (optional)	Magnification	30~200X	60~400X
	Focus distance	1.14±.08"	1.14±.08"
	View filed	.31×.21"~.05×.03"	.15×.11"~.024×.016"

DIGITAL AUTO FOCUS MICROSCOPE (WITH DISPLAY)
PART NO. 5303-AF103

TAKE PICTURES AND VIDEOS

- ▶ 1080P high-definition image
- ▶ Auto focus camera
- ▶ Take pictures and videos, saved to memory card
- ▶ Automatic exposure and white balance
- ▶ Brightness, contrast ratio, gain are adjustable
- ▶ Display cross hair (blue/green/red/yellow/black/brown colors)

AUTO FOCUS

SPECIFICATION

List Price (\$)	3158.00
Sale Price (\$)	2684.00
Magnification	20X~123X
Sensor	1/2.8" CMOS
Pixel	2M
Resolution	1920×1080
Frame rate	60fps
Output	HDMI
Power supply	power adapter
Dimension (L×W×H)	22.44×11.81×16.93"
Weigh	14.33lb

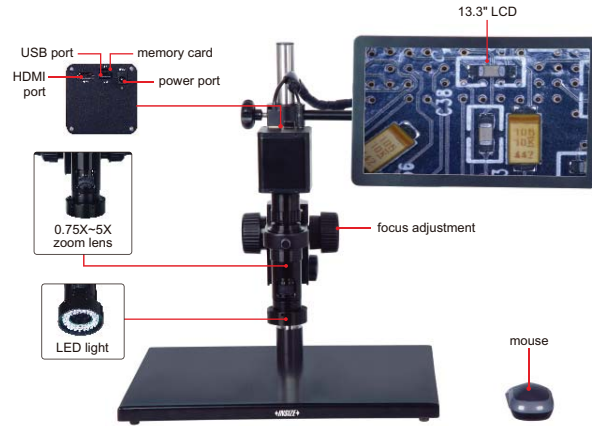

STANDARD DELIVERY

Main unit	1 pc
0.5X camera adapter	1 pc
1X auxiliary objective	1 pc
8G memory card and holder	1 pc
White/black plate	1 pc
Mouse	1 pc
HDMI cable	1 pc
Power adpter	2 pcs

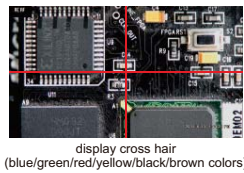

display cross hair (blue/green/red/yellow/black/brown colors)



X-Y glass stage (optional) (X-Y travel: 2.91×2.36")

OPTIONAL ACCESSORY

1X camera adapter	ISM-DL-CA1X
2X auxiliary objective	ISM-DL-OB2X
X-Y glass stage (travel: 2.91×2.36")	ISM-DL-STAGE
X-Y metal stage	ISM-DL-STAGE1
LED auxiliary illumination	ISM-DL-LED
Coaxial light illumination	ISM-DL-COAXIAL

MAGNIFICATION, FOCUS DISTANCE AND VIEW FIELD

Auxiliary Objective	Specification	Camera adapter	
		0.5X (included)	1X (optional)
1X (included)	Magnification	20~123X	40~246X
	Focus distance	1.89~3.31"	1.89~3.31"
	View filed	.51×.28~.09×.04"	.25×.14~.04×.02"
2X (optional)	Magnification	40~246X	80~492X
	Focus distance	.94~1.65"	.94~1.65"
	View filed	.26×.14~.04×.02"	.13×.07~.02×.01"

AUTO FOCUS DISTANCE

Zoom objective scale	0.75X	1X	1.5X	2X	2.5X
Auto focus distance	1.89~3.31"	1.97~3.07"	2.17~2.87"	2.44~2.80"	2.56~2.76"
Zoom objective scale	3X	3.5X	4X	4.5X	5X
Auto focus distance	2.60~2.76"	2.64~2.76"	2.68~2.76"	2.68~2.76"	2.68~2.76"

DIGITAL MICROSCOPE WITH DISPLAY (ECONOMIC MODEL)
PART NO. 5304-DL100

TAKE PICTURES AND VIDEOS

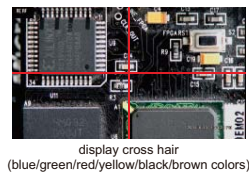

display cross hair (blue/green/red/yellow/black/brown colors)



8G memory card and holder (included)

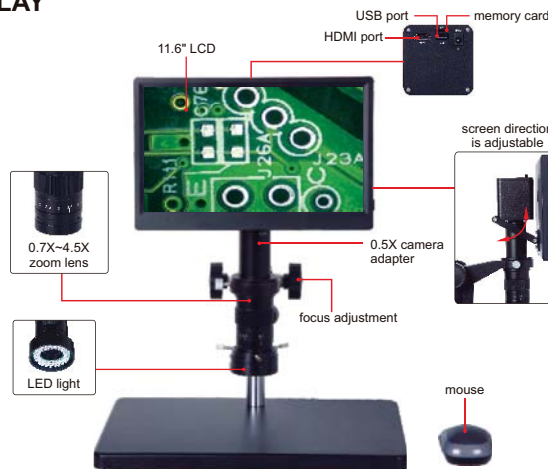

- ▶ 1080P high-definition image
- ▶ Take pictures and videos, saved to memory card
- ▶ Automatic exposure and white balance
- ▶ Brightness, contrast ratio, gain are adjustable
- ▶ Display cross hair (blue/green/red/yellow/black/brown colors)

SPECIFICATION

List Price (\$)	1477.00
Sale Price (\$)	1255.00
Magnification	28X~91X
Focus distance	1.10~3.07"
View field	.51×.28~.12×.08"
Sensor	1/2.8" CMOS
Pixel	2M
Resolution	1920×1080
Frame rate	60fps
Output	HDMI
Power supply	power adapter
Dimension (L×W×H)	14.96×10.24×19.69"
Weight	8.82lb

Part No.	List Price (\$)	Sale Price (\$)
ISM-DL-STAGE	222.00	189.00

OPTIONAL ACCESSORY

X-Y glass stage (travel: 2.91×2.36")	ISM-DL-STAGE
--------------------------------------	--------------

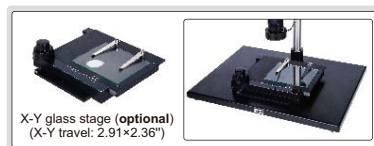

X-Y glass stage (optional) (X-Y travel: 2.91×2.36")

STANDARD DELIVERY

Main unit	1 pc
8G memory card and holder	1 pc
Mouse	1 pc
White/black plate	1 pc
Power adapter	2 pcs

3D MOTORIZED ROTATION MICROSCOPE (WITH DISPLAY) PART NO. 5301-D400

SUITABLE TO CHECK CONVEX OBJECTS AND WALL OF HOLE

TAKE PICTURES AND VIDEOS

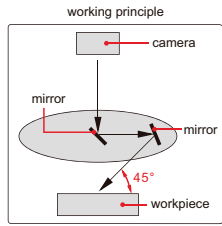

- ▶ 1080P high-definition 3D image
- ▶ Take pictures and videos, saved to memory card
- ▶ Automatic white balance and exposure
- ▶ Brightness, contrast ratio, gain are adjustable

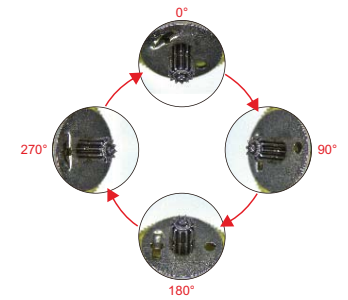
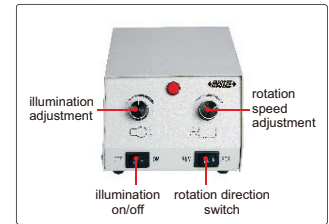
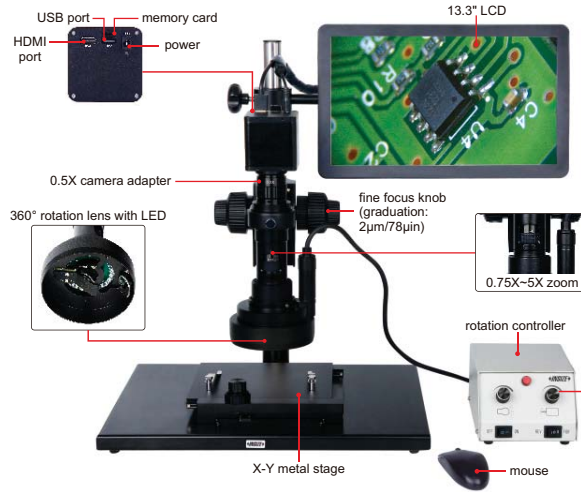

SPECIFICATION

List Price (\$)	7941.00
Sale Price (\$)	6750.00
Magnification	12X~75X
View field	.14×.08~.94×.57"
Focus distance	1.02"
View angle	45°
Sensor	1/2.8" CMOS
Pixel	2M
Resolution	1920×1080
Frame rate	60fps
Output	HDMI
Rotation speed	5~27RPM, stepless adjustment
Power supply	power adapter and 110/220V, 50/60Hz
Dimension (L×W×H)	22.44×11.81×16.93"
Weight	22.05lb

STANDARD DELIVERY

Main unit	1 pc
Rotation controller	1 pc
X-Y metal stage	1 pc
8G memory card and holder	1 pc
White/black plate	1 pc
Mouse	1 pc
Power adapter	2 pcs



DIGITAL MEASURING MICROSCOPE

- ▶ Can take pictures and videos
- ▶ Supplied with software

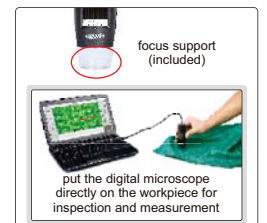
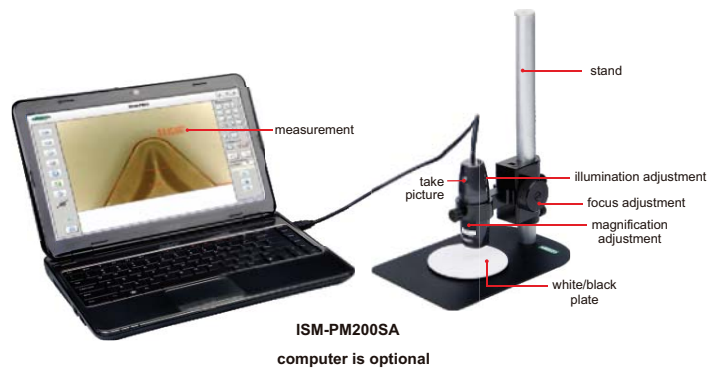

SPECIFICATION

Part No.	ISM-PM200SA	ISM-PM200SB
List Price (\$)	399.00	399.00
Sale Price (\$)	339.00	339.00
Magnification	10X~200X	10X~200X
Focus distance	short focus distance	short focus distance
Stand	standard	universal
Focus support	included	
Calibration rule	graduation 0.1mm/.004" and 1mm/.039"	
Pixel	2M (resolution: 1600×1200)	
Illumination	built-in adjustable LED	
Power supply	USB 2.0 cable (voltage required: 5±0.1V)	

filter (optional)

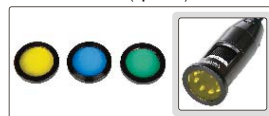

OPTIONAL ACCESSORY

Green filter	ISM-PM-GREEN
Yellow filter	ISM-PM-YELLOW
Blue filter	ISM-PM-BLUE

MAGNIFICATION, FOCUS DISTANCE, VIEW FIELD AND ACCURACY

Magnification	Focus distance	View field	Accuracy
50X	.83"	.32×.25"	1.2mil
100X	.51"	.15×.12"	0.6mil
150X	.63"	.10×.08"	0.4mil
200X	.75"	.07×.06"	0.3mil

WiFi DIGITAL MEASURING MICROSCOPE
PART NO. ISM-WF200



optional stand (Part No. ISM-WSTD, optional)



filter (optional)



- ▶ Maximum working distance is 200" under WiFi mode
- ▶ Can be connected to multiple iPads, Android devices or computers at the same time under WiFi mode
- ▶ Take pictures and videos
- ▶ Supplied with software

SPECIFICATION

List Price (\$)	399.00
Sale Price (\$)	339.00
Magnification	10X~200X
Pixel	1.3M (resolution: 1280x1024)
Illumination	built-in adjustable LED
Power supply	built-in rechargeable battery

Part No.	List Price (\$)	Sale Price (\$)
ISM-WSTD	135.00	115.00

STANDARD DELIVERY

Microscope	1 pc
Base support	1 pc
Focus support ring for 80X/150X	1 pc
Focus support ring for 60X/200X	1 pc
Glass calibration rule (graduation 0.1mm)	1 pc
Plastic calibration rule (graduation 1mm)	1 pc
USB cable and software	1 pc
AC/DC adapter	1 pc



software CD (included)



plastic calibration rule (graduation 1mm, included)

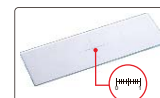

glass calibration rule (graduation 0.1mm, included)

MAGNIFICATION, FOCUS DISTANCE, VIEW FIELD AND ACCURACY

Magnification	Focus distance	View field	Accuracy
50X	.83"	.32x.25"	1.2mil
100X	.51"	.15x.12"	0.6mil
150X	.63"	.10x.08"	0.4mil
200X	.75"	.07x.06"	0.3mil

OPTIONAL ACCESSORY

Stand	ISM-WSTD
Green filter	ISM-PM-GREEN
Yellow filter	ISM-PM-YELLOW
Blue filter	ISM-PM-BLUE

1 Software ISM-PAD (for iPad by WiFi)

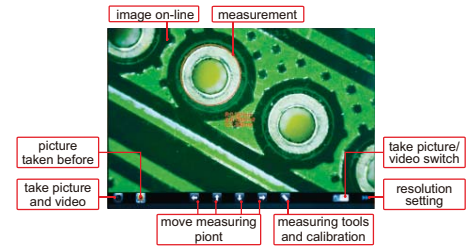

2 Software ISM-APK (for Android devices by WiFi)

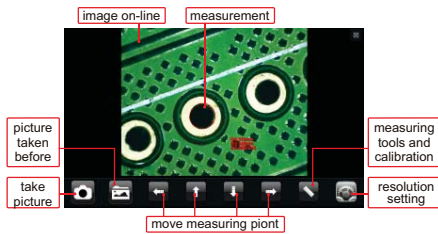

3 Software ISM-WF Partner (for computer by WiFi)

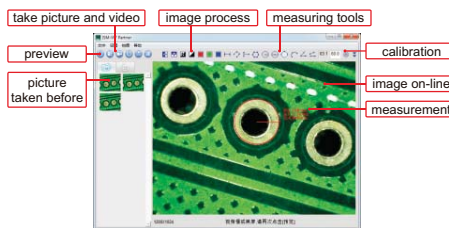

4 Software ISM-PRO (for computer by USB cable)

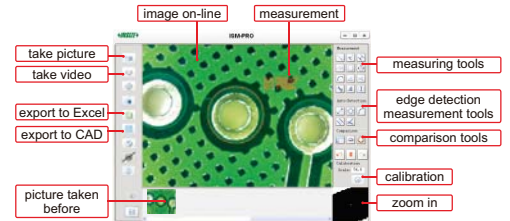

ROUGHNESS TESTER
PART NO. ISR-C003



calibration block (included)



- ▶ Unit: μm, μin
- ▶ Automatic power off

STANDARD DELIVERY

Main unit	1 pc
Calibration block	1 pc
AC/DC adapter	1 pc

SPECIFICATION

List Price (\$)	1735.00
Sale Price (\$)	1475.00
Parameters	Ra, Rz, Rq, Rt
Range	Ra, Rq: 2~590μin Rz, Rt: 4~1968μin
Accuracy	±10%
Resolution (Ra)	0.01μin
Probe	type: piezoelectric stylus radius/angle: 393μin/90° stylus material: diamond
Measuring force	.012ozf
Measuring unit	μin/μm
Cut off	.01/.03/.1"
Evaluation length	.05" for cut off .01" .15" for cut off .03" .2" for cut off .1"
Traverse speed	.03"/s
Power	built-in rechargeable battery
Dimension (L×W×H)	4.17×2.75×.94"
Weight	.44lb

ROUGHNESS TESTER (SEPARABLE TYPE) CODE ISR-C300

CAN BE OPERATED BY COMPUTER OR MOBILE PHONE DATA OUTPUT BLUETOOTH TOUCH SCREEN

- ▶ Roughness tester can be operated by mobile phone (only android system) or computer
- ▶ Data can be output to Excel by connecting with computer via bluetooth or USB cable
- ▶ Support bluetooth printer, 22 roughness parameters
- ▶ Meet ISO, DIN, ANSI, JIS standards
- ▶ Display roughness values, profile and curve
- ▶ Memory of maximum 100 data and waveform
- ▶ Built-in lithium battery, working time more than 50 hours
- ▶ Touch screen, automatic power off

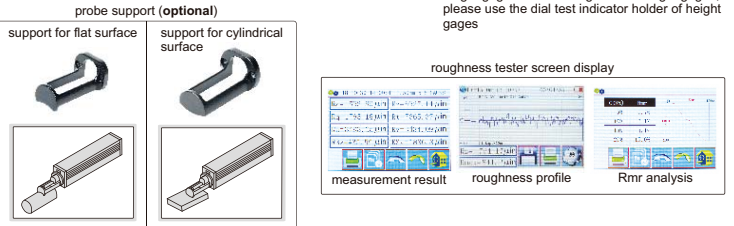
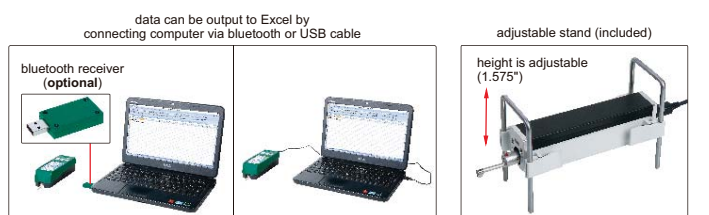
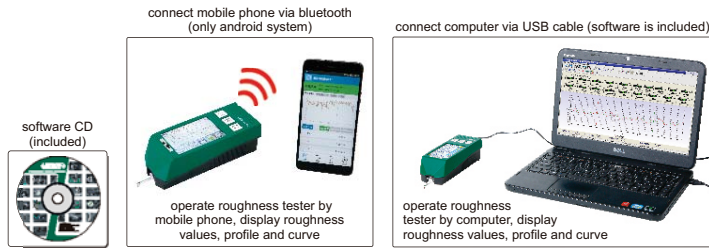
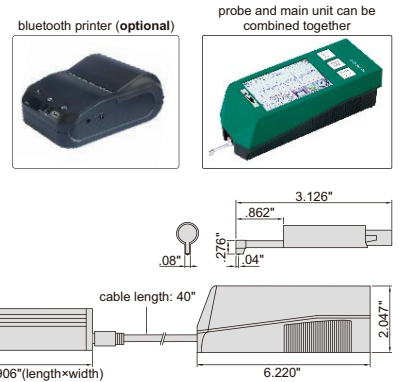

SPECIFICATION

List Price (\$)	2357.00
Sale Price (\$)	2003.00
Parameters	Ra, Rz, Rq, Rv, Rp, Rs, R3z, R3y, Rt, Rc, Rz (JIS), Rk, Rku, Rsm, Rpc, Rpk, Rvk, Rsk, Mr1, Mr2, Ry, Rmax
Range	X axis: 17.5mm Z axis: 320µm(-160µm~160µm)
Accuracy	±10%
Resolution (Ra)	0.002µm/±20µm 0.004µm/±40µm 0.006µm/±80µm 0.02µm/±160µm
Probe	type: inductive stylus radius/angle: 5µm/90° stylus material: diamond
Measuring force	4mN
Measuring unit	µm/µin
Cut off	0.25/0.8/2.5mm
Number of cut-offs	1~5
Traverse speed	0.135mm/s, 0.5mm/s, 1mm/s
Memory	100 measurement results
Output	USB and bluetooth
Power	built-in rechargeable battery
Dimension (L×W×H)	158×64×52mm
Weight	400g

STANDARD DELIVERY

Main unit	1pc
Standard probe	1pc
Calibration block and support	1pc of each
Connecting cable (long and short)	1pc of each
Magnetic stand adapter	1pc
Adjustable stand	1pc
Touch pen	1pc
USB cable and software	1pc
AC/DC adapter	1pc

STANDARD DELIVERY

Extension rod	ISR-C002-ER
Small hole probe	ISR-C002-PROBE
Tiny hole probe	ISR-C002-SBP
Deep groove probe	ISR-C002-DGP
Bluetooth printer	ISR-C002-PRINTER
Height gage adapter	ISR-C300-LB1
Bluetooth receiver	ISR-C300-RECEIVER
Support for flat surface	ISR-C300-COVER1
Support for cylindrical surface	ISR-C300-COVER2

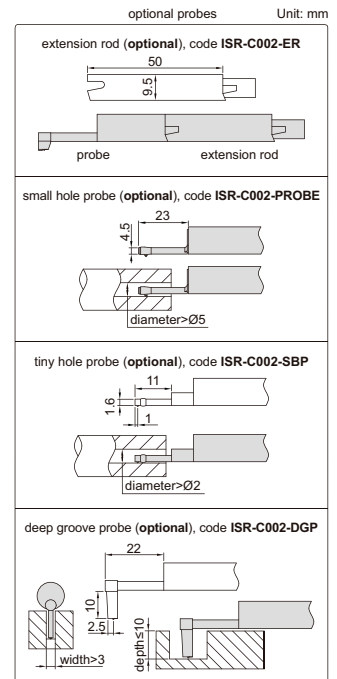

INSIZE USA

Add: 3492 Diversified Drive
Loganville, GA 30052
Tel: 470-240-2520
Fax: 470-448-4771
E-mail: info@insizeus.com

Connect with us on:



Distributed by: